

SECTION ONE

- **UNIVERSAL TOOLING**
- **CHANNELS**
- **ANGLES**
- **DESK / COUNTER TRIM**
- **CLIPS**

Universal Tooling

Universal tooling has been designed for a variety of channel and angle profiles to be used in various materials and gauges.

Channels

< Degrees = 90°

Equal or Unequal Legs = 3/16" to 2 1/4"

Webs = 9/16" to 18"

Tolerance = ± .030"

Inside Radius = Sharp

Stock Thickness = .048" to .125"

Materials = CR, HRP&O, GALV, AL, BR, Bz, St. St.*

* Certain alloys may necessitate gage reductions

Angles

< Degrees = 90°

Equal or Unequal Legs = 1" to 3"

Tolerance = ± .030"

Inside Radius = Sharp, 1/16"

Stock Thickness = .048" to .187"

Materials = CR, HRP&O, GALV, AL, BR, Bz, St. St.*

* Certain alloys may necessitate gage reductions

Channels And Angles

The channels and angles shown in this section have many uses either as structural members or as decorative trim. Occasionally, the same shape can serve both purposes, depending upon the shape and material selection.

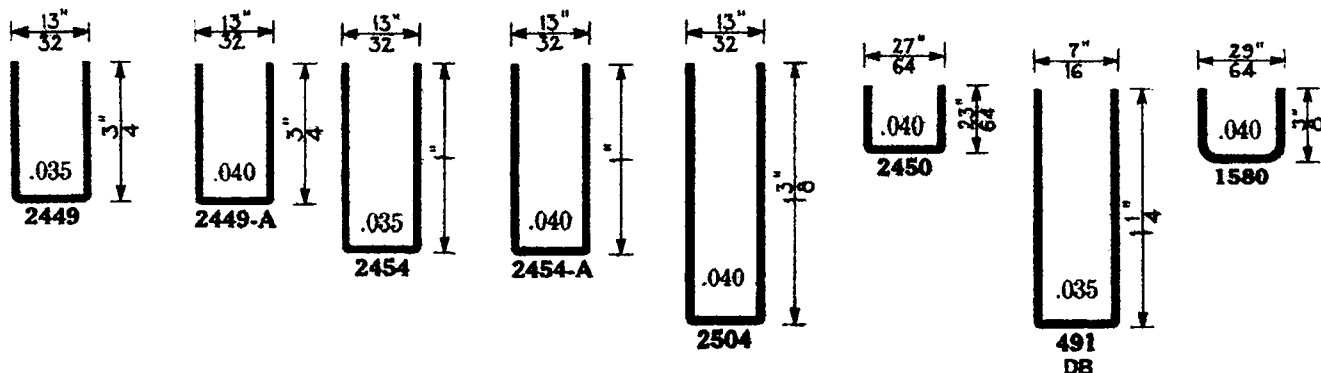
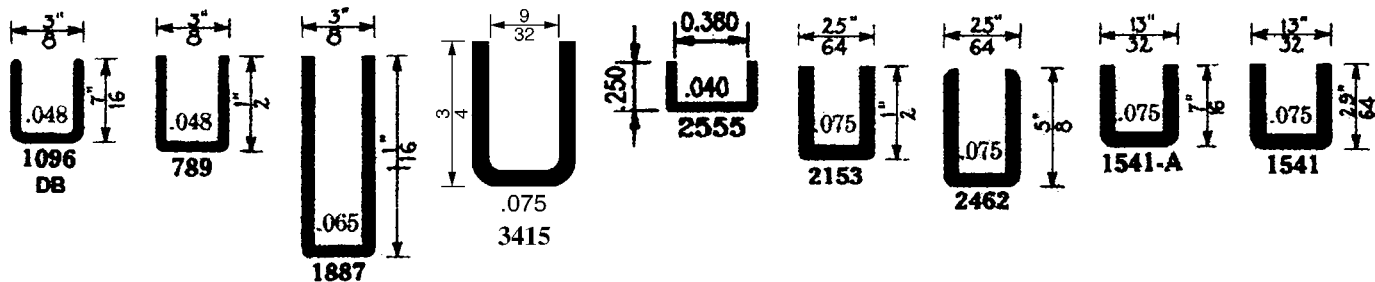
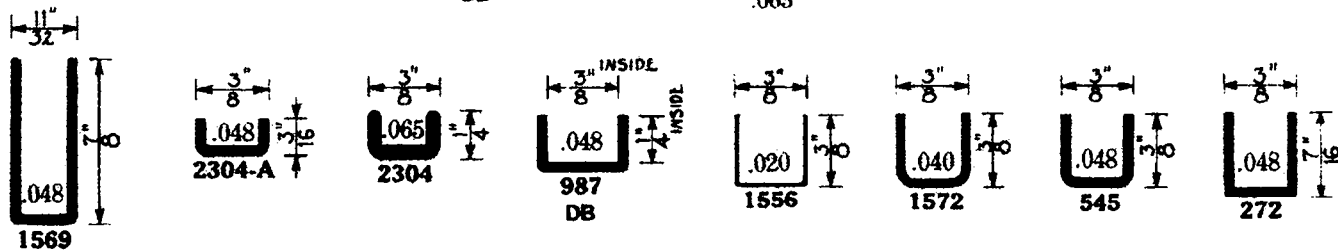
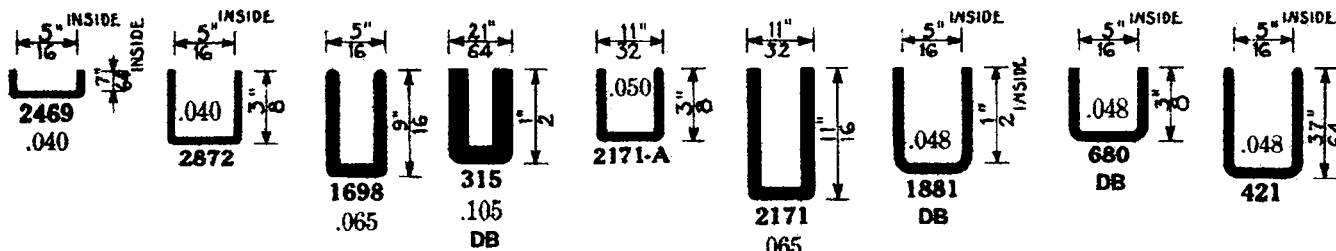
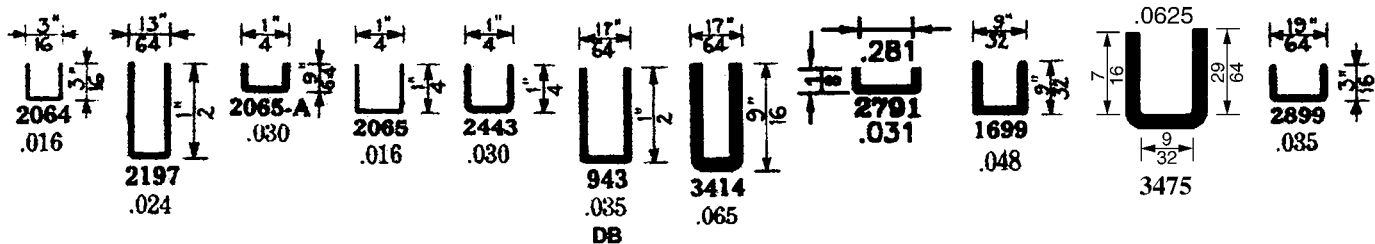
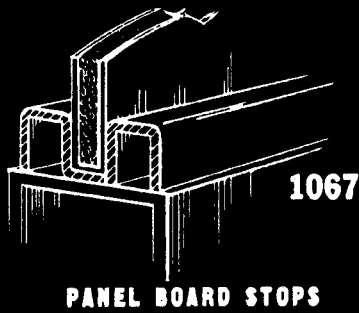
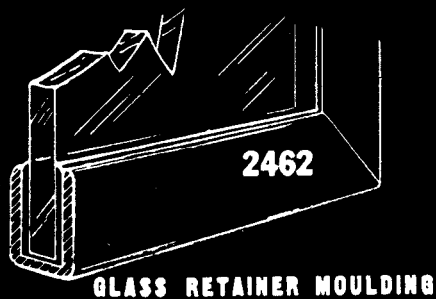

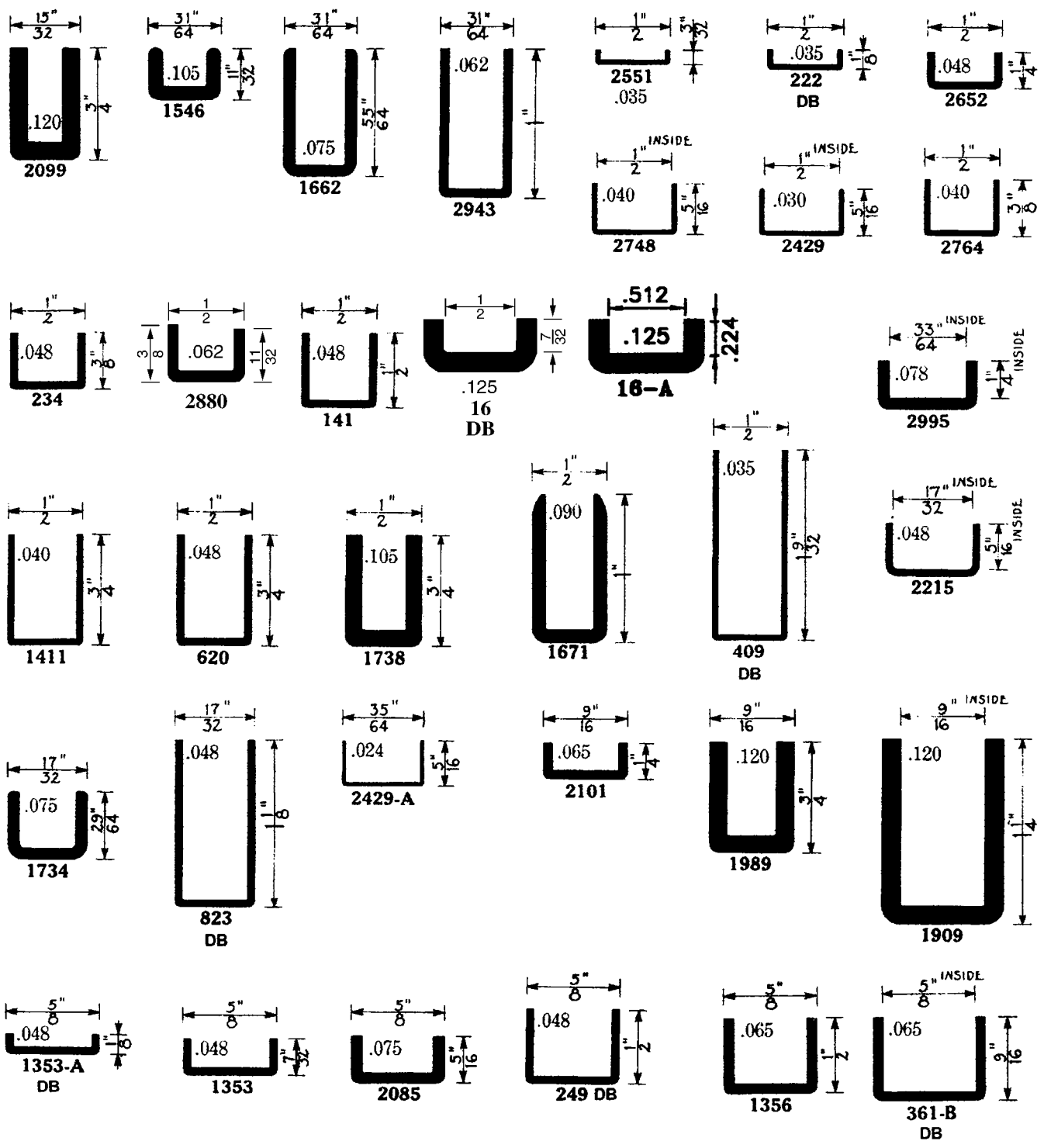
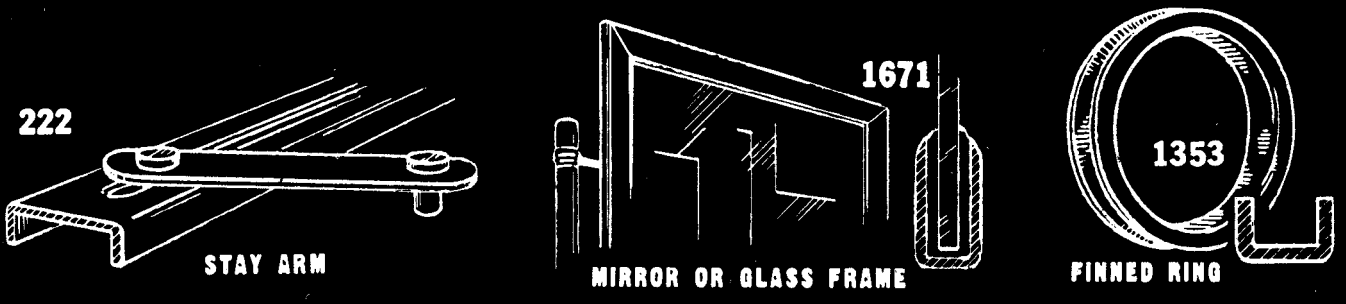

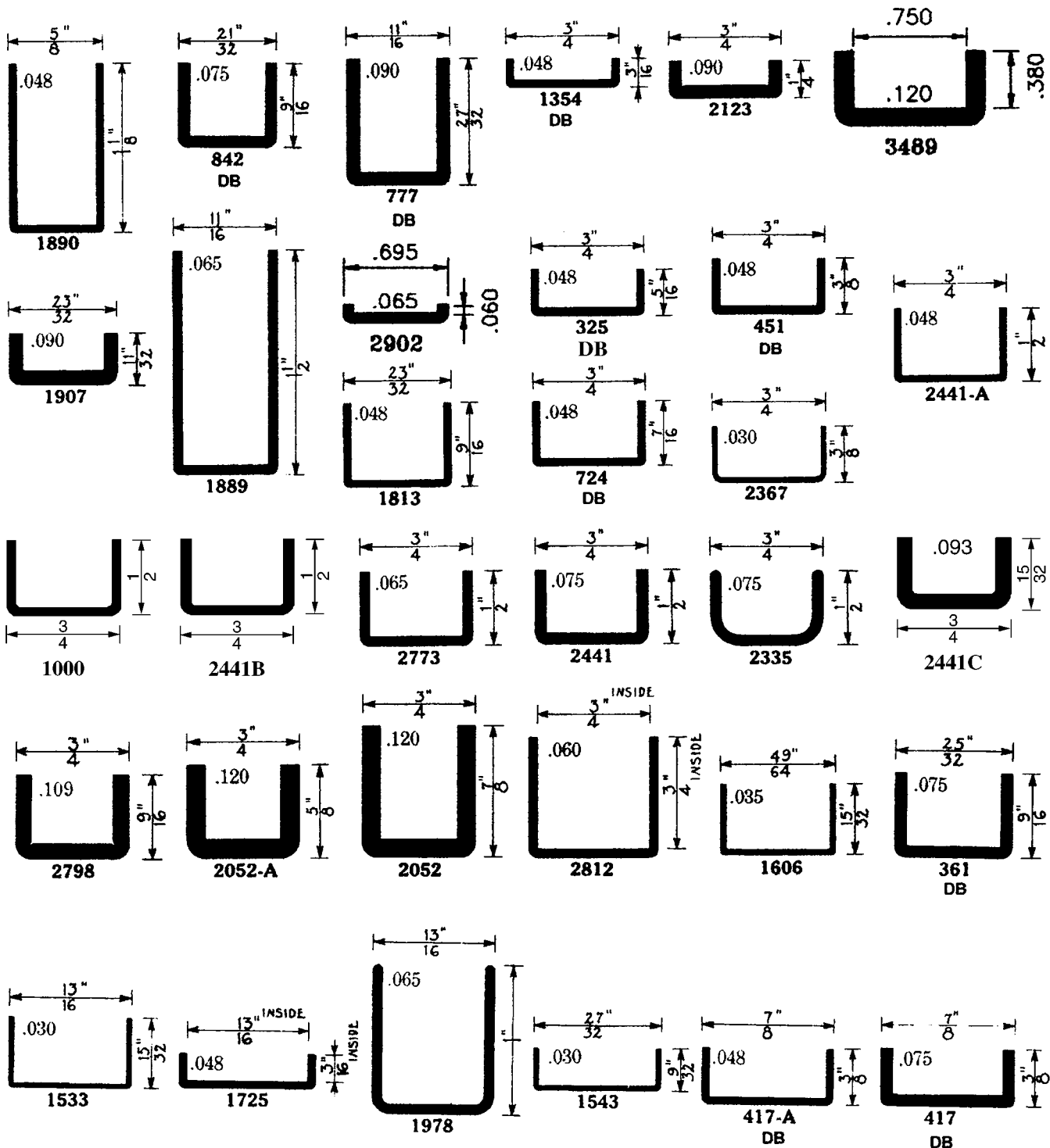
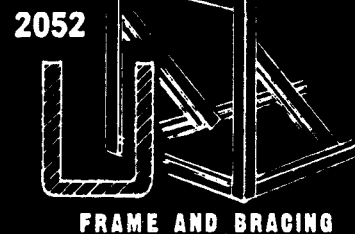
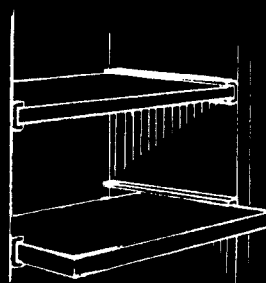
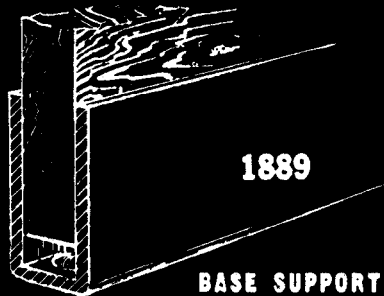

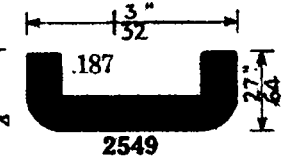
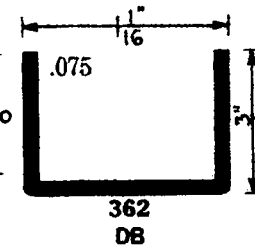
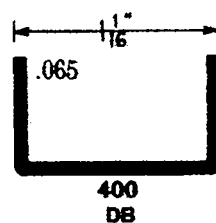
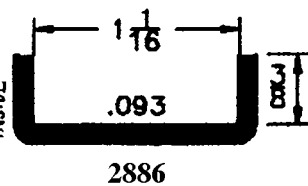
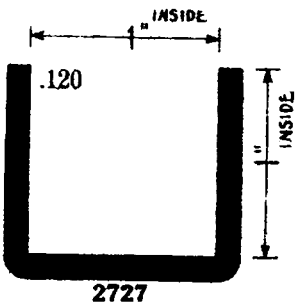
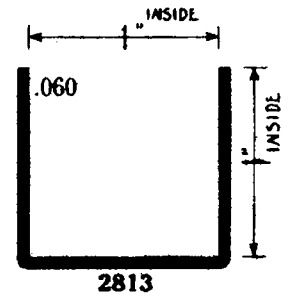
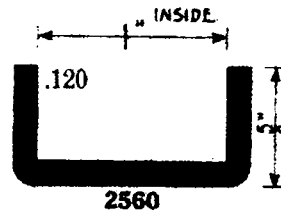
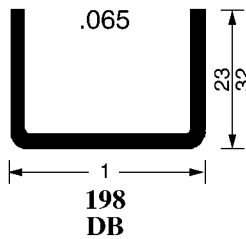
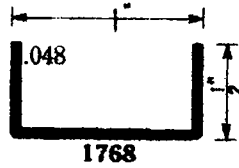
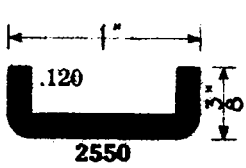
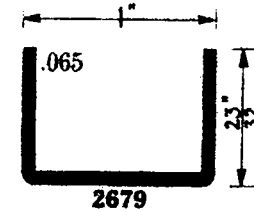
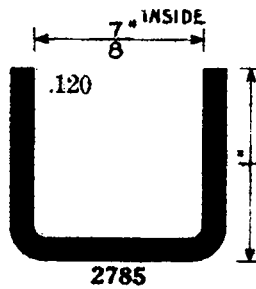
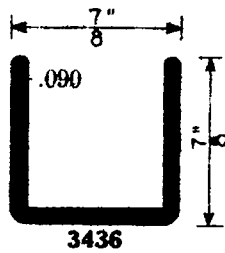
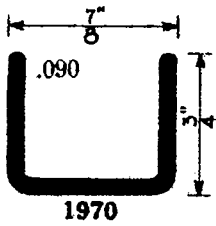
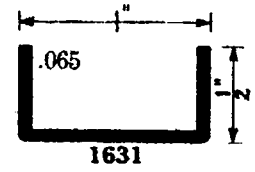
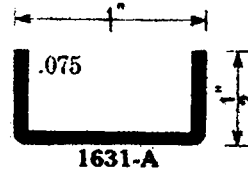
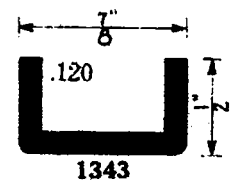
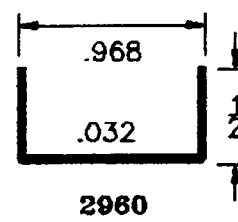
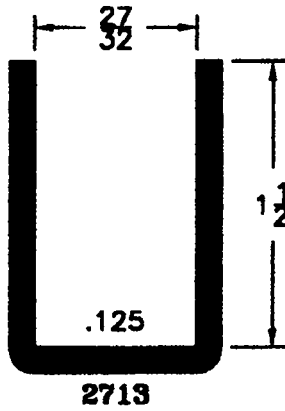
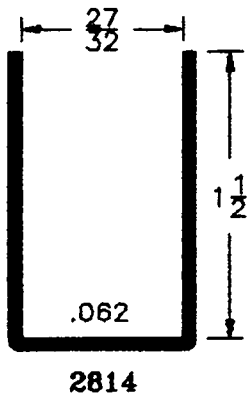
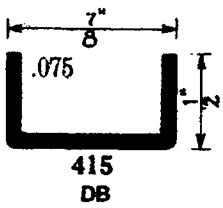
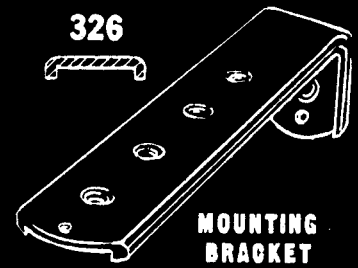
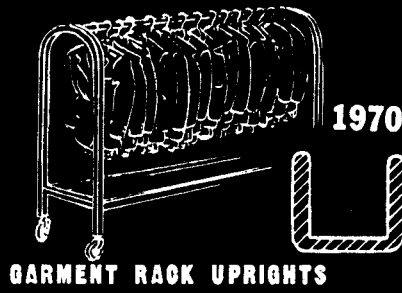
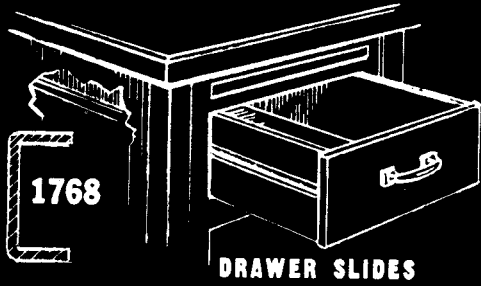

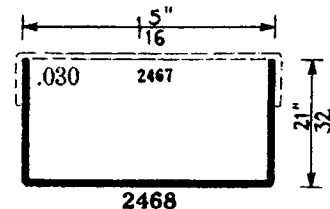
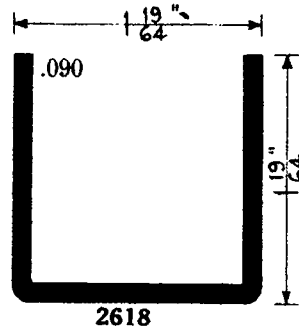
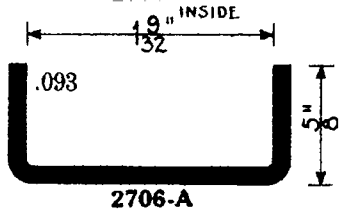
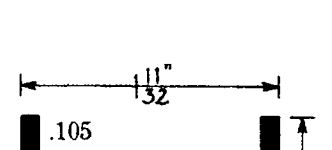
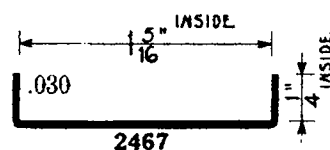
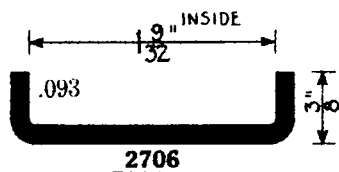
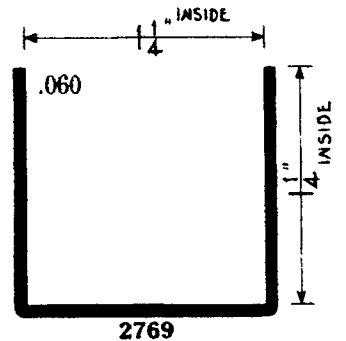
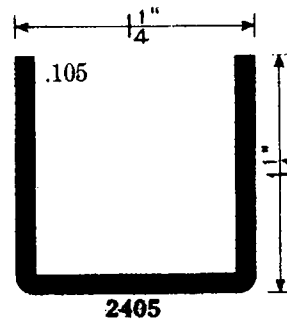
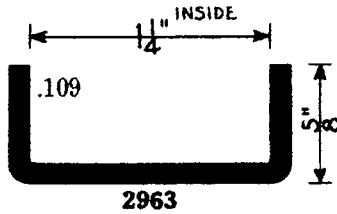
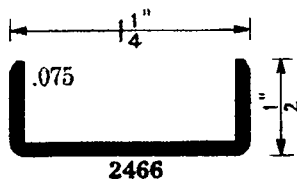
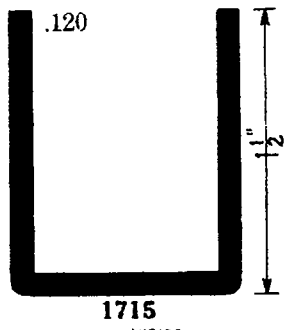
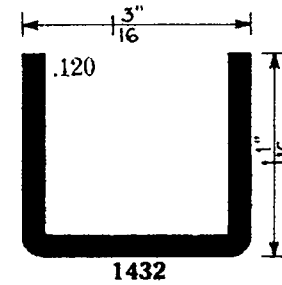
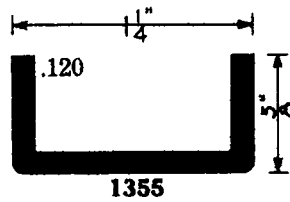
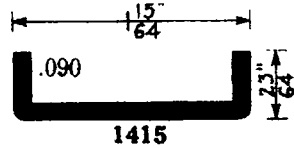
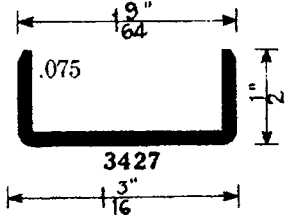
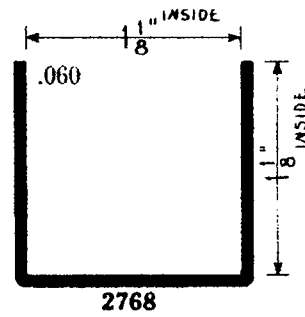
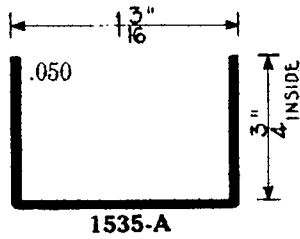
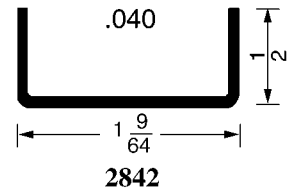
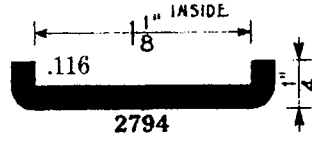
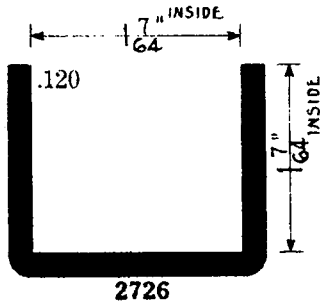
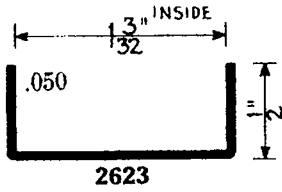
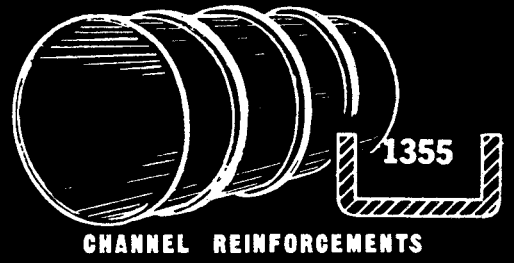
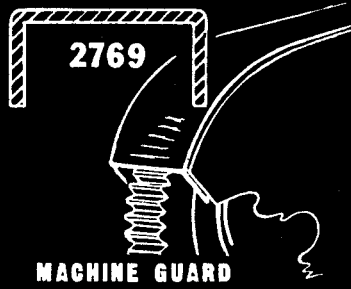
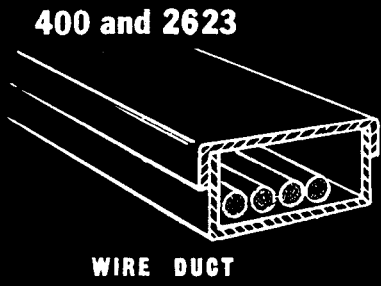

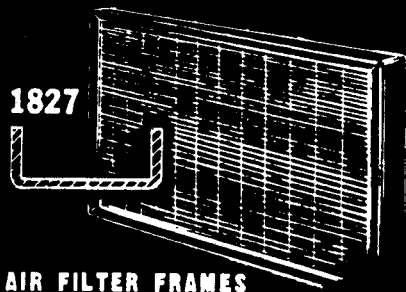

1827
AIR FILTER FRAMES

2467 and 2468

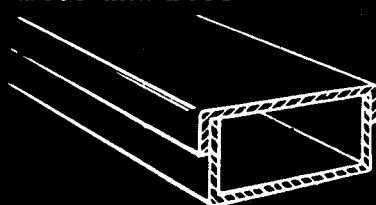

CHANNEL DUCT

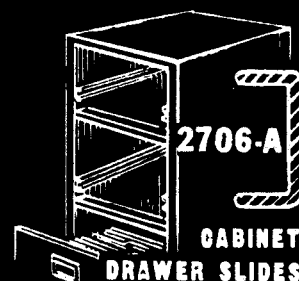

2706-A
CABINET
DRAWER SLIDES

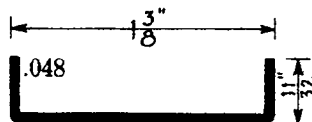

1108
DB

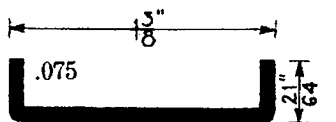

1863

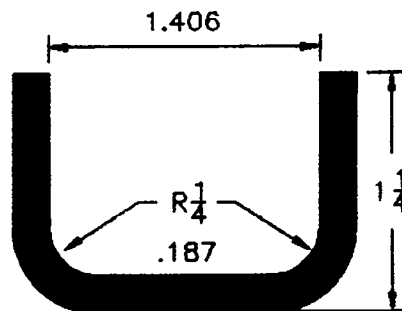

3407

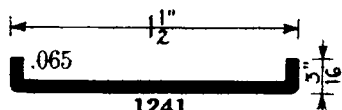

1241
DB

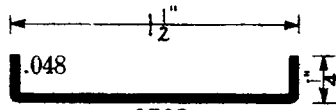

1702

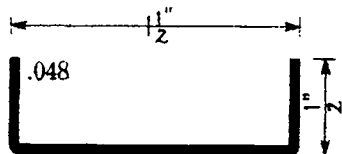

1649-A

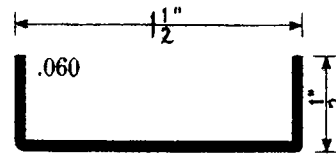

1649-B

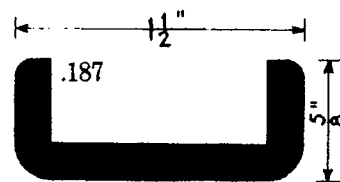

2548

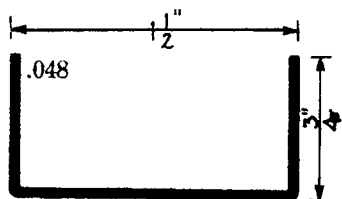

1649

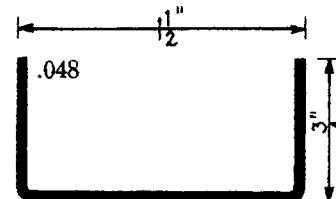

226 DB

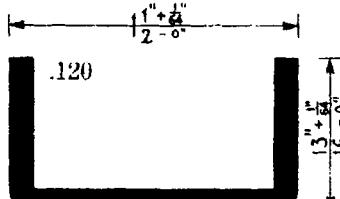

2399

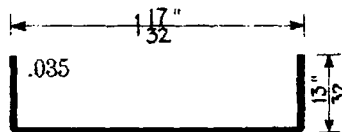

2843

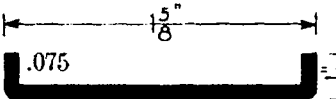

2139

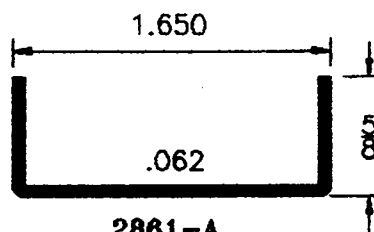

2861-A

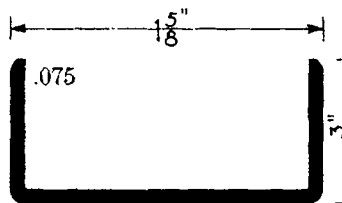

2513

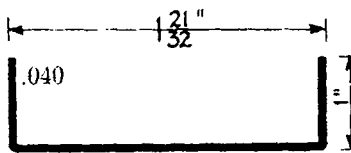

2844

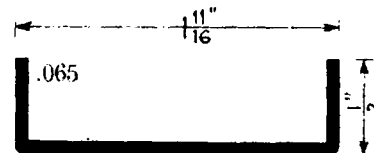

298
DB

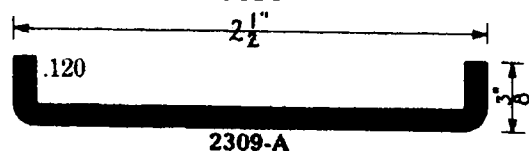
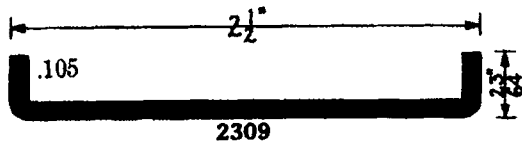
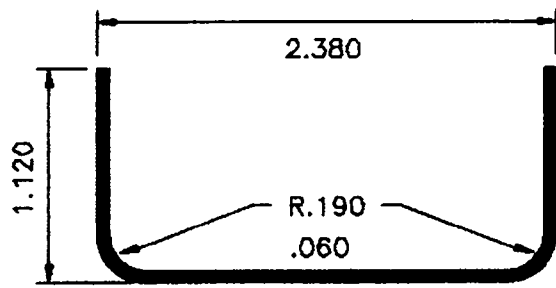
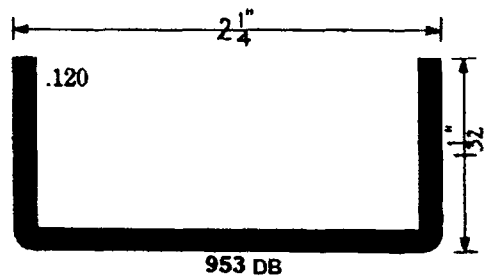
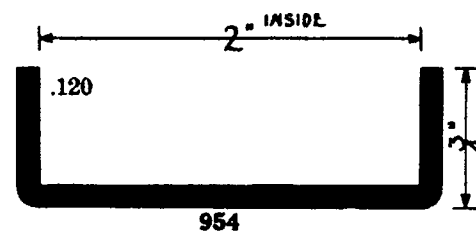
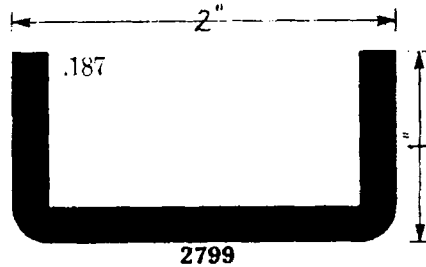
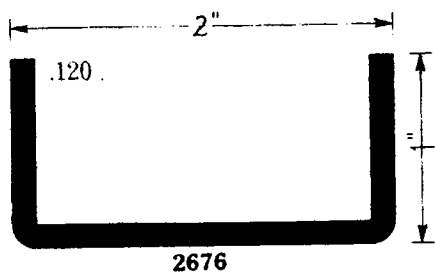
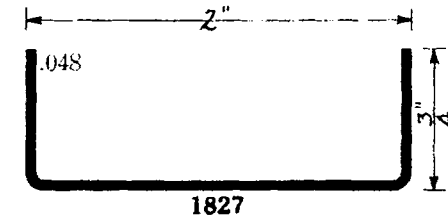
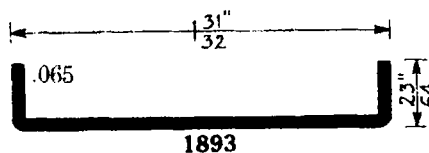
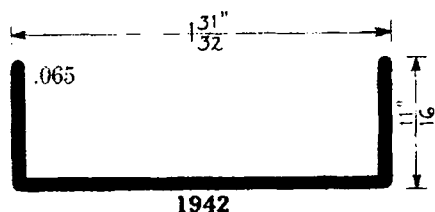
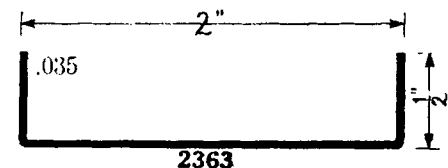
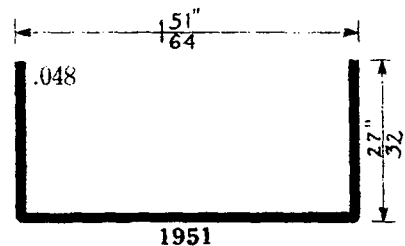
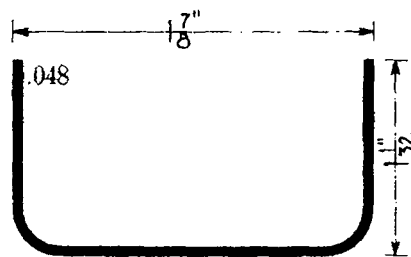
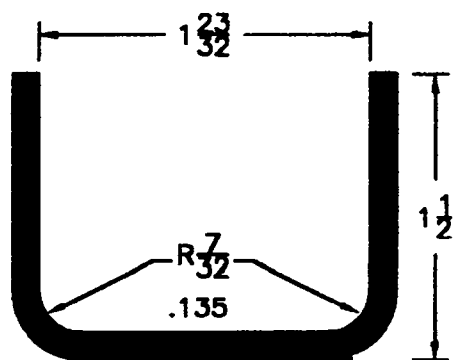
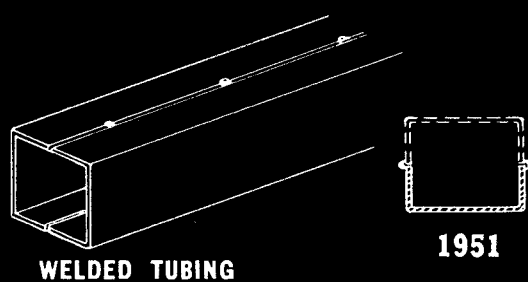
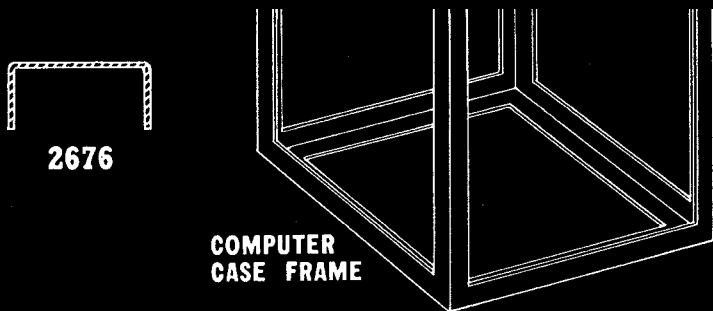

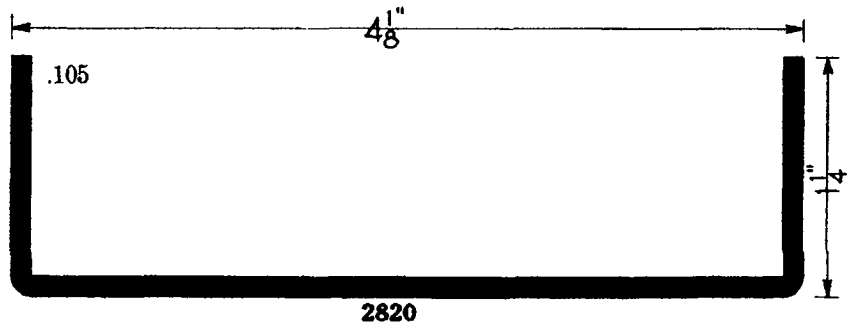
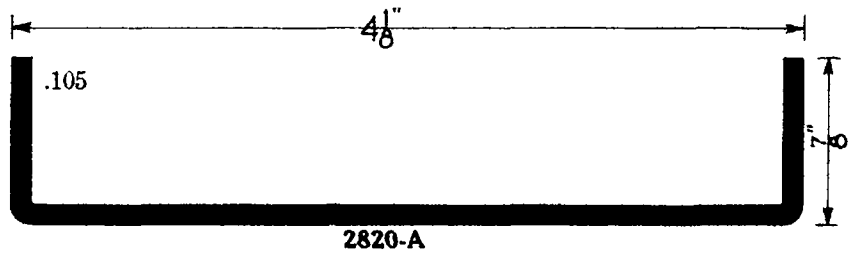
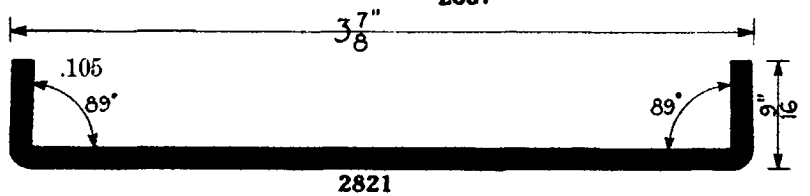
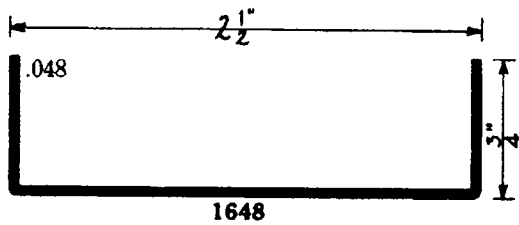
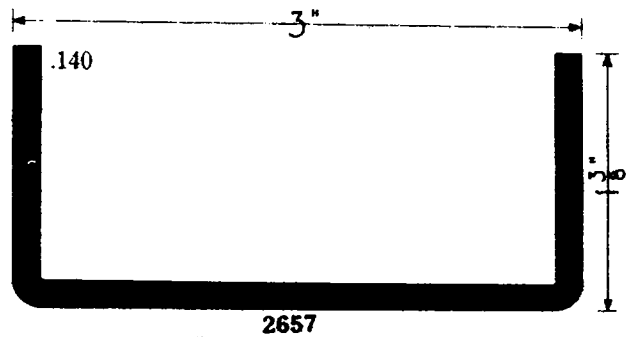
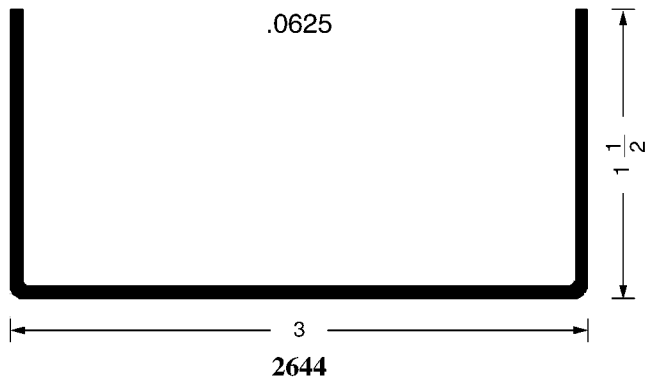
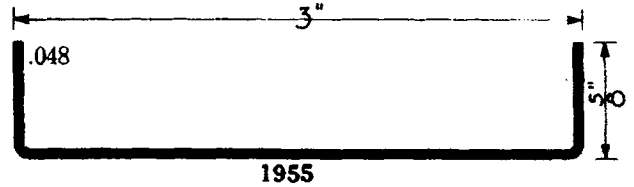
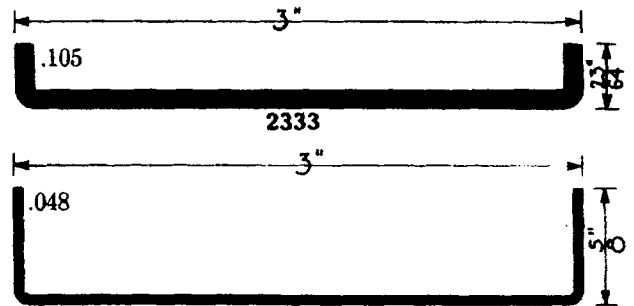
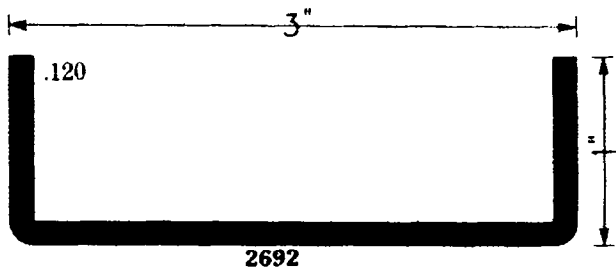
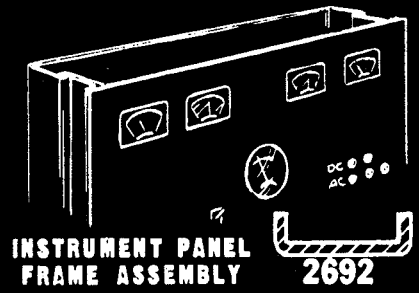
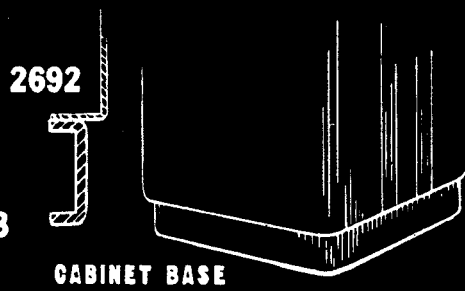
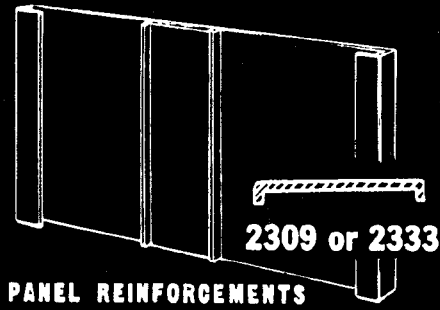

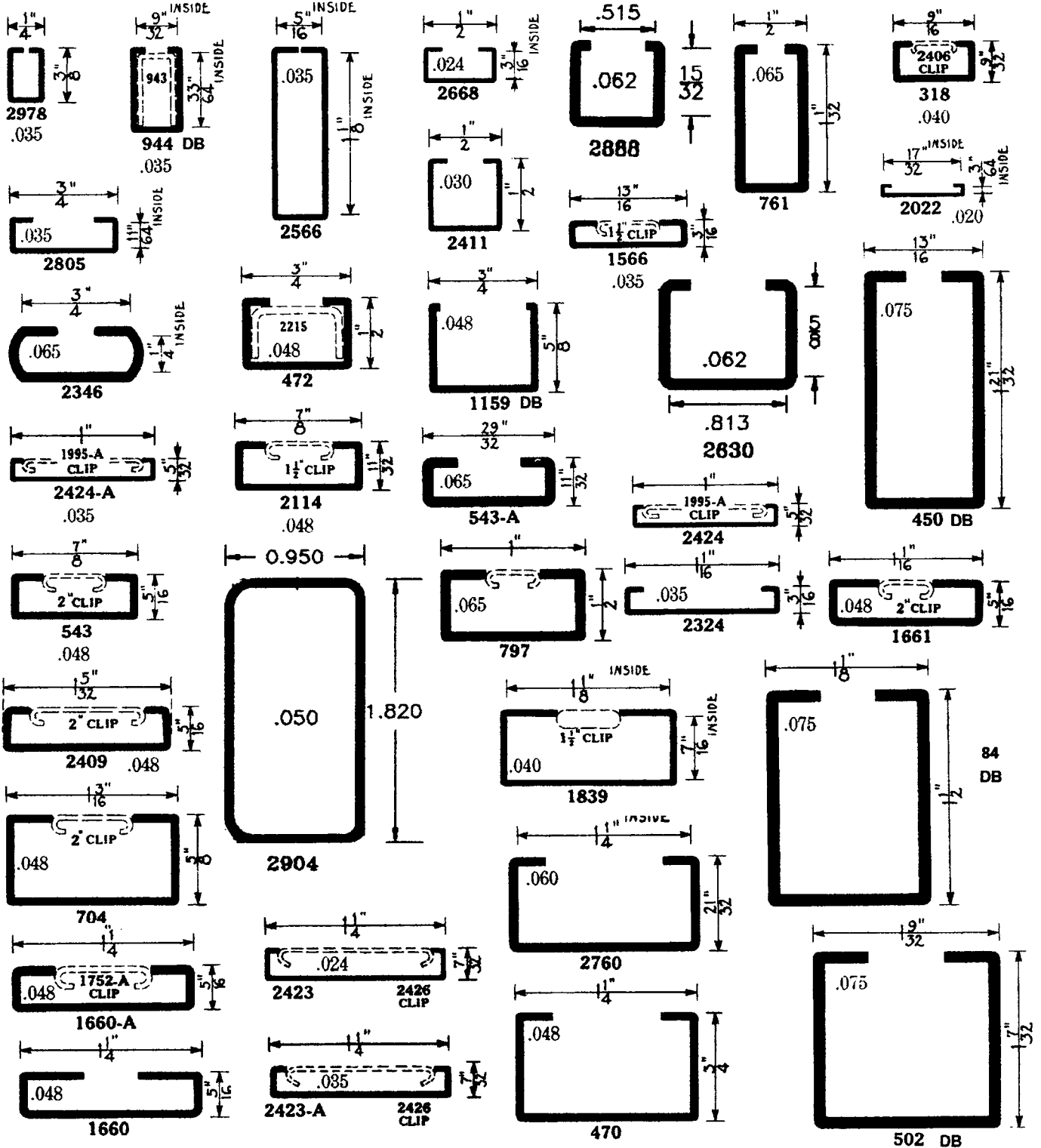
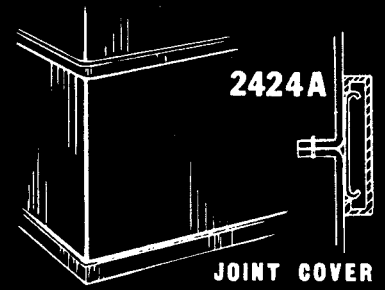
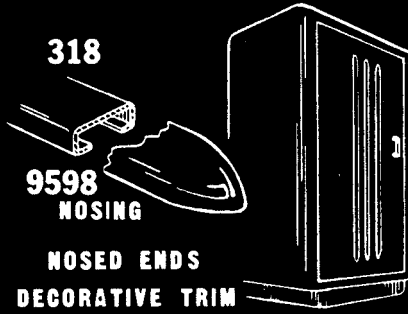
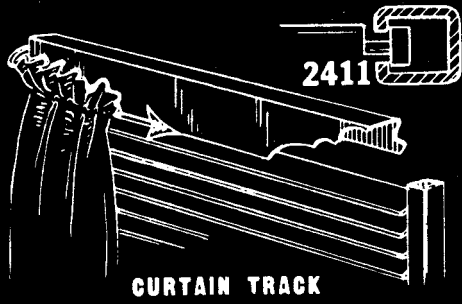

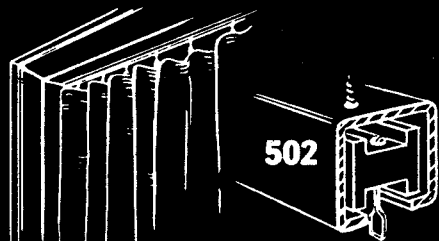

SLIDE CURTAIN TRACK

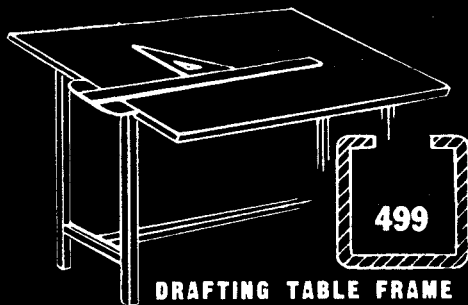

DRAFTING TABLE FRAME

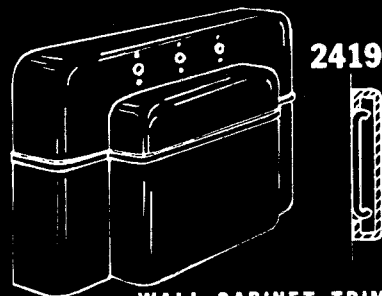

WALL CABINET TRIM

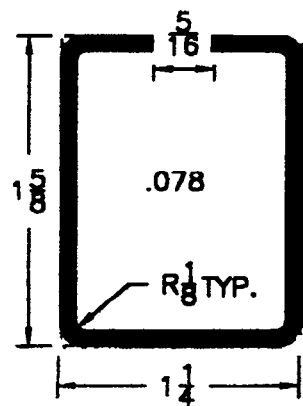

2444

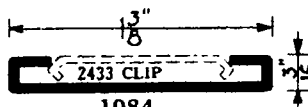

1084
.048

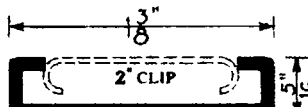

1168 DB
.065

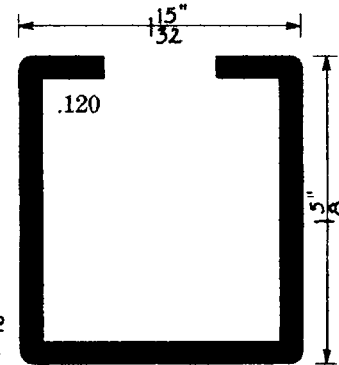

499
DB

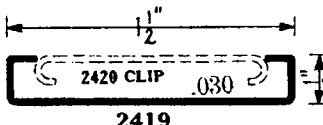

2419

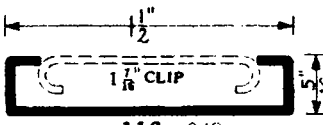

116 .048

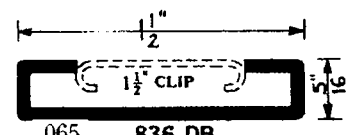

.065 836 DB

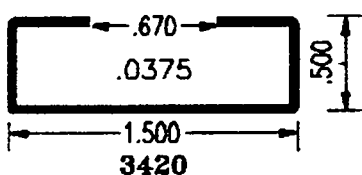

3420

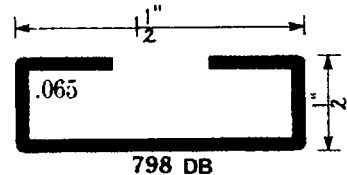

798 DB

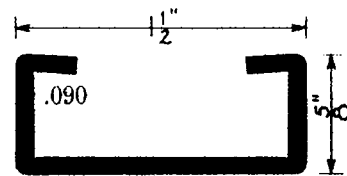

515

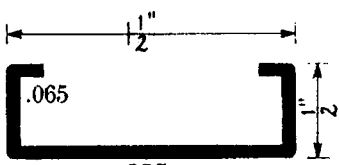

295 DB

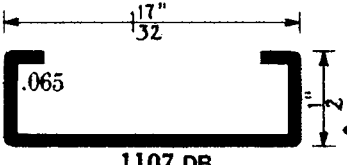

1107 DB

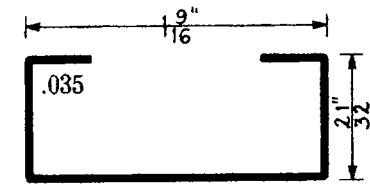

1157 DB

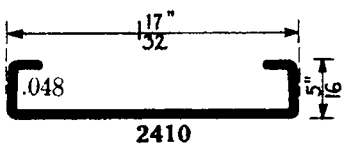

2410

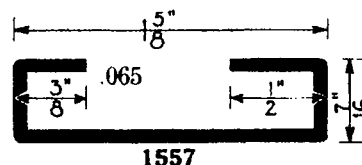

1557

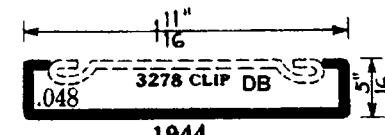

1944

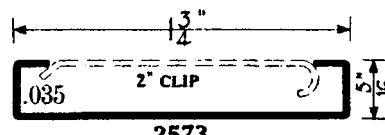

2573

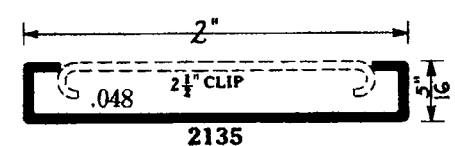

2135

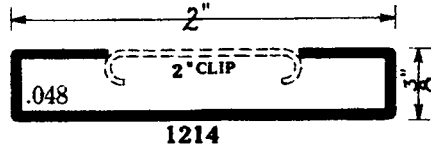

1214

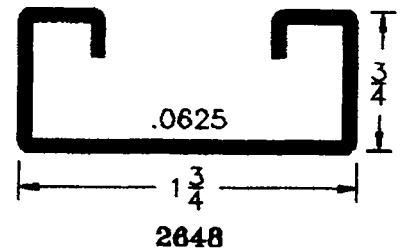
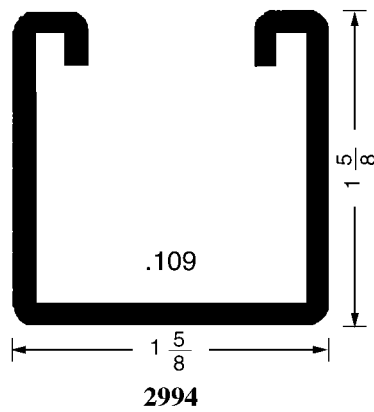
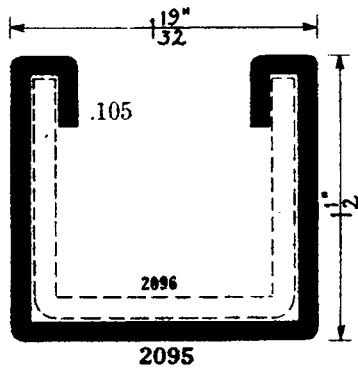
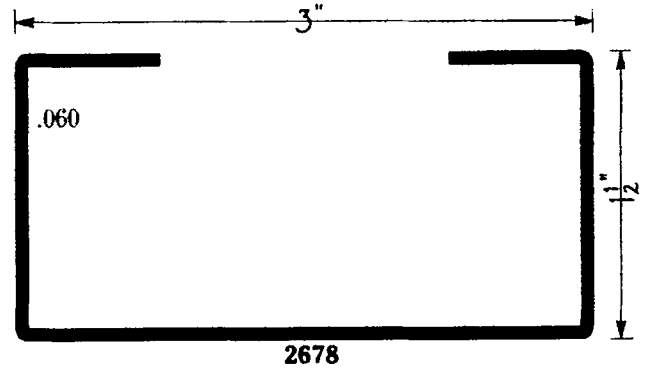
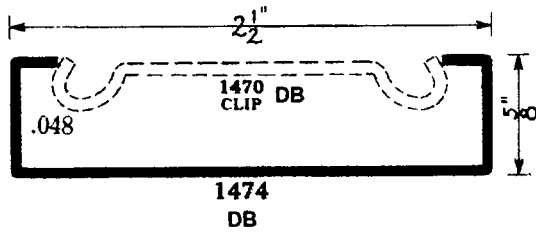
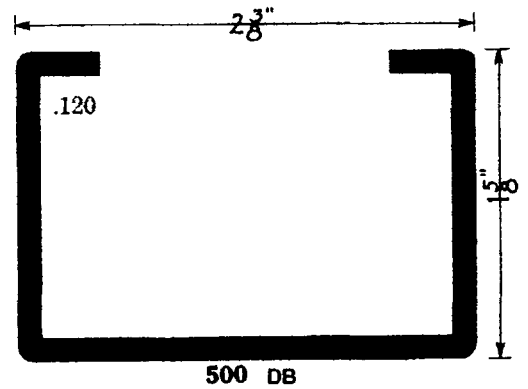
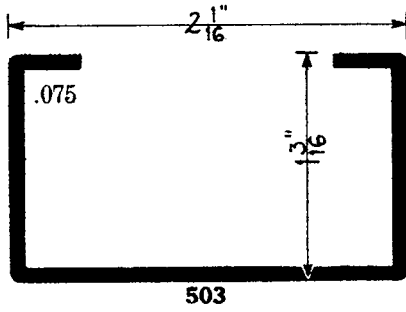
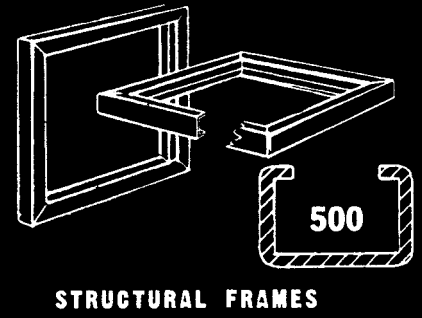
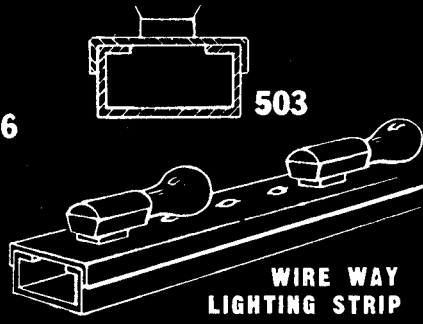
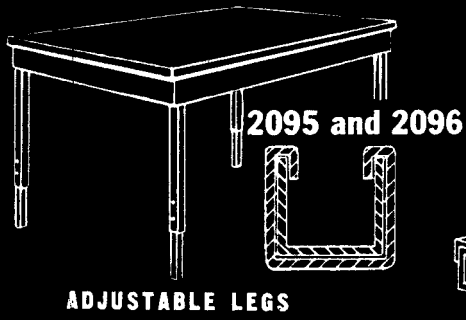

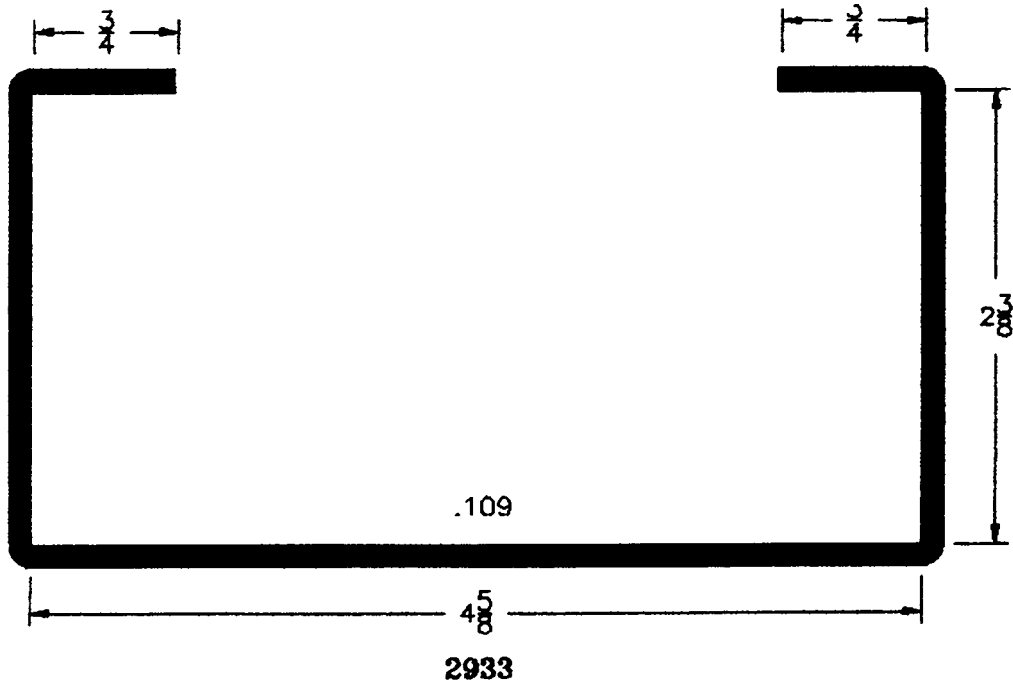
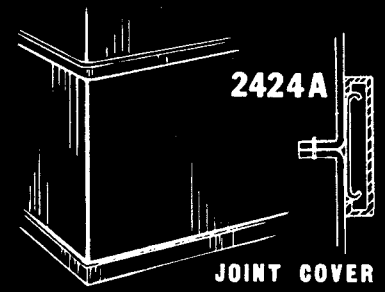
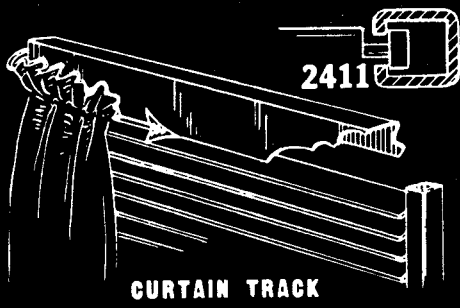

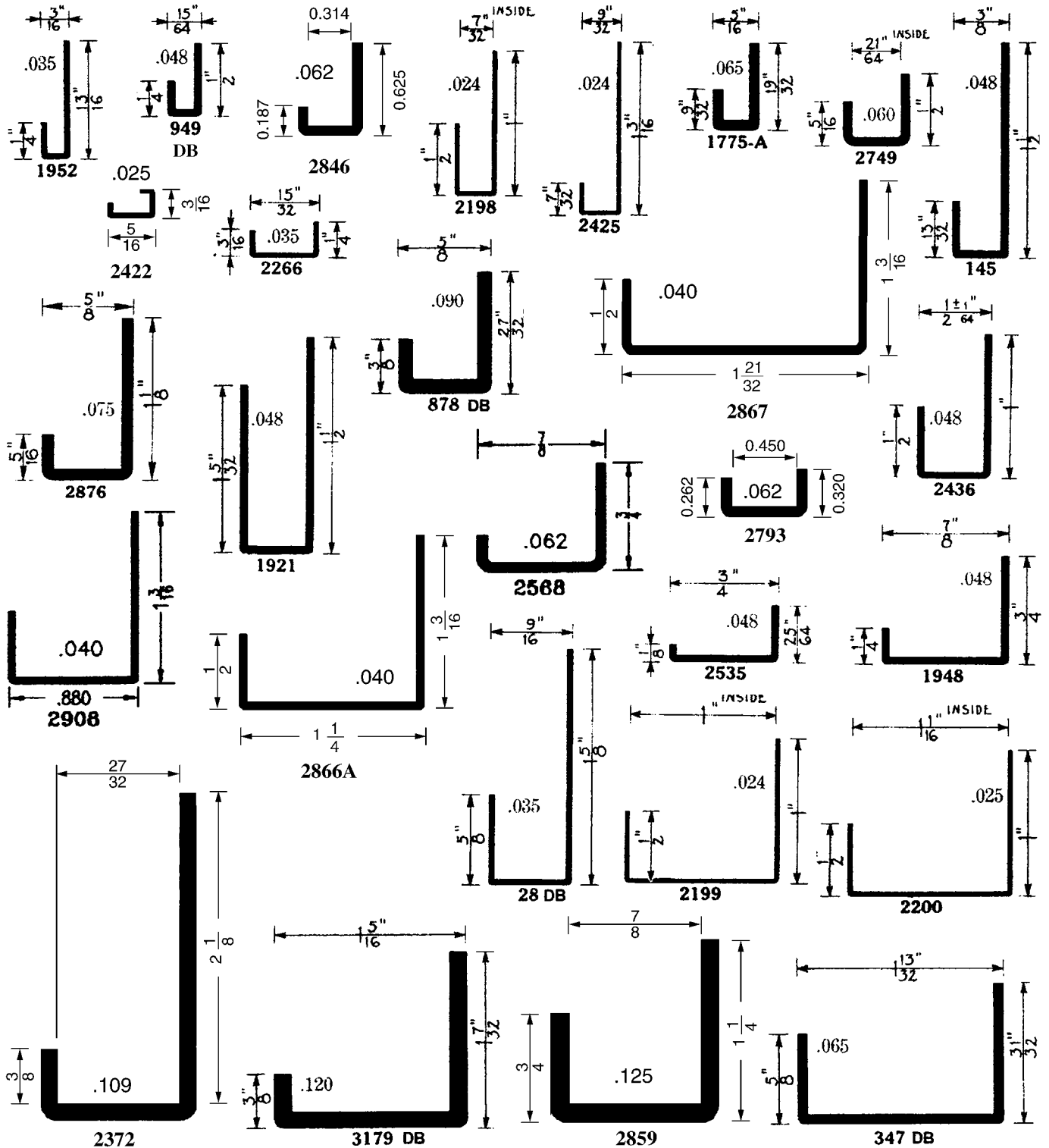
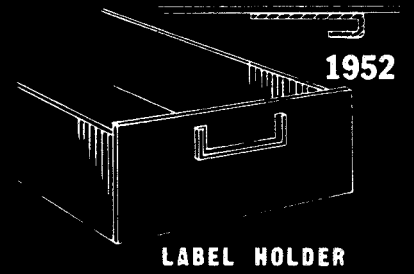
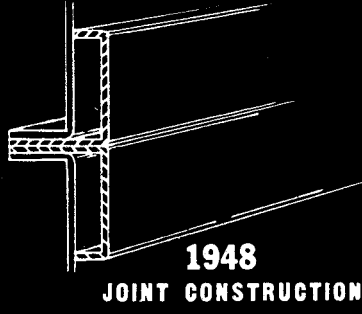
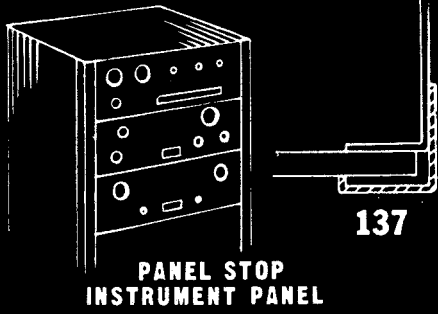

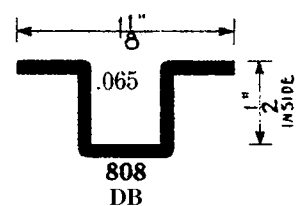
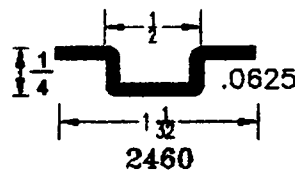
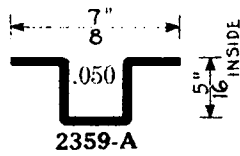
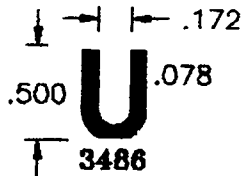
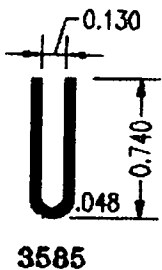
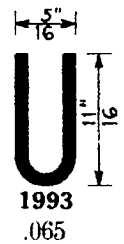
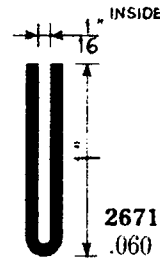
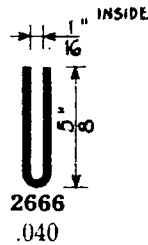
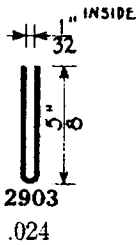
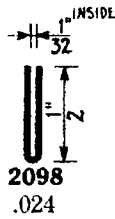
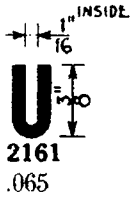
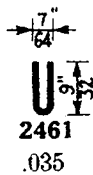
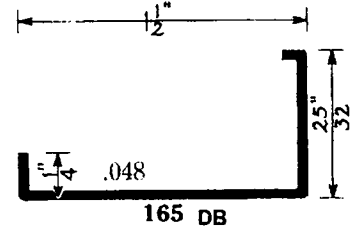
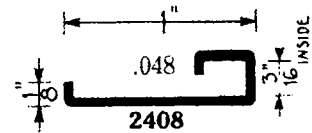
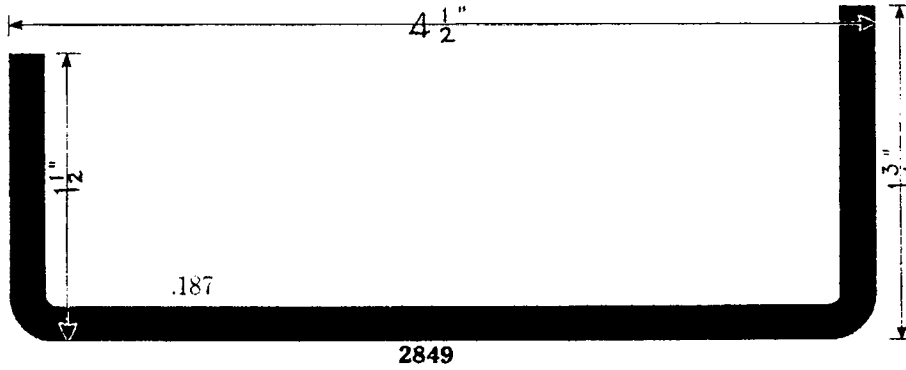
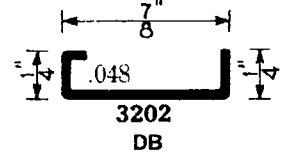
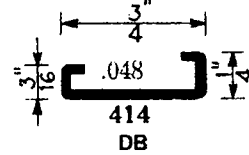
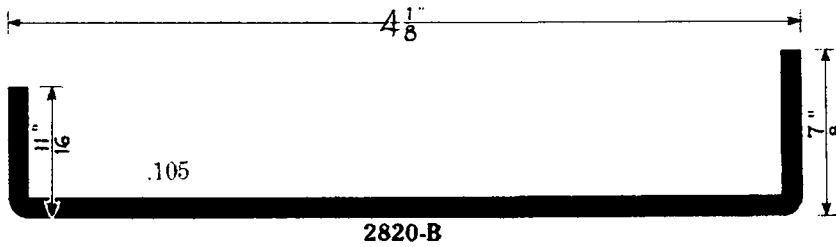
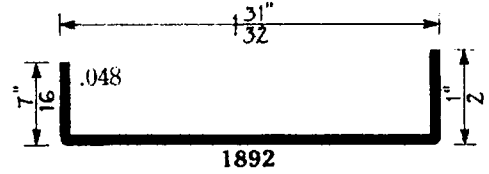
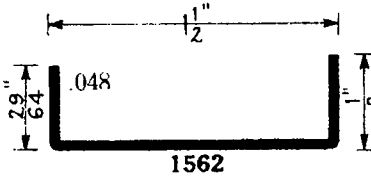
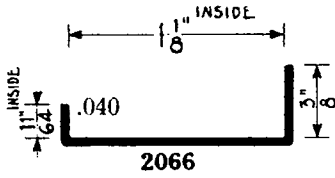
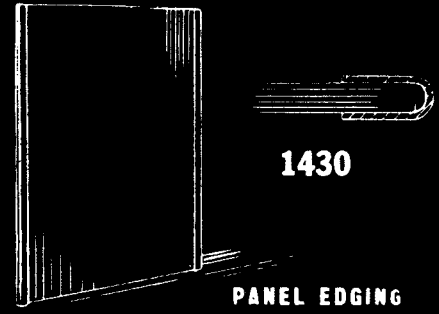
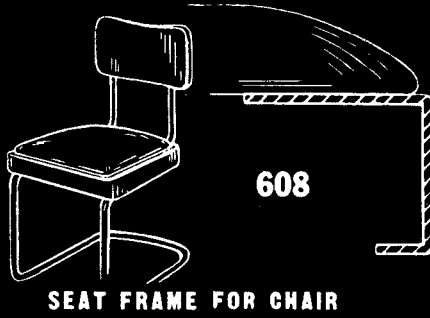

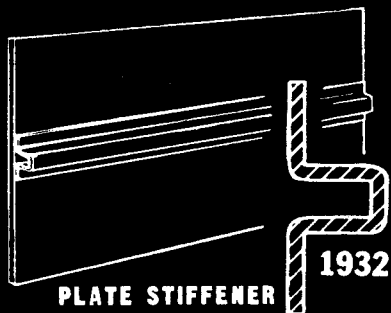

1932

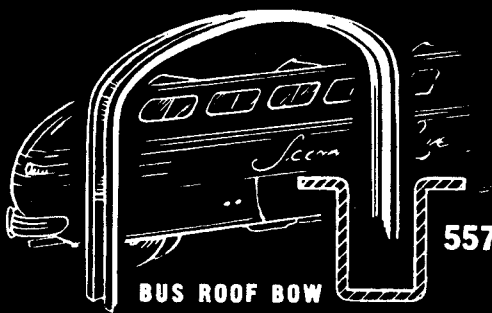

557

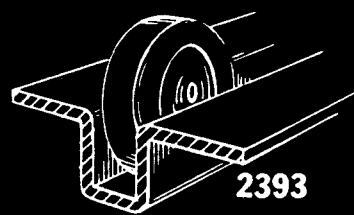

2393

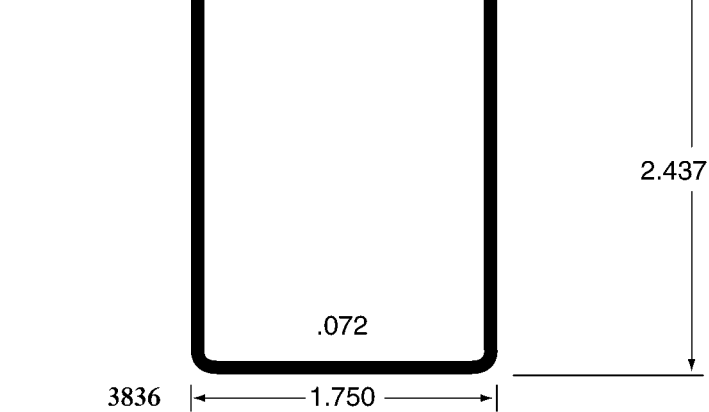
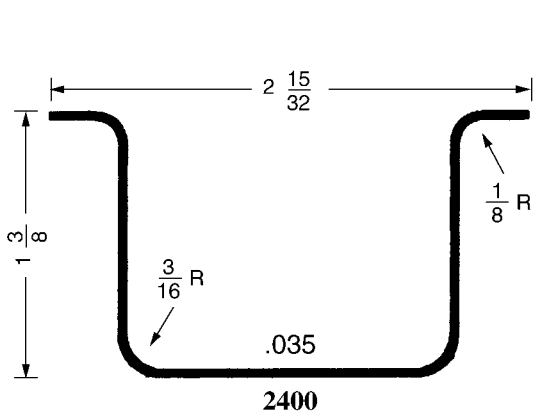
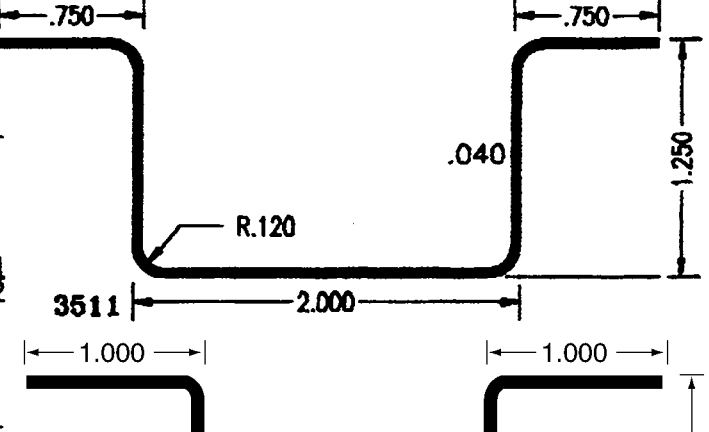
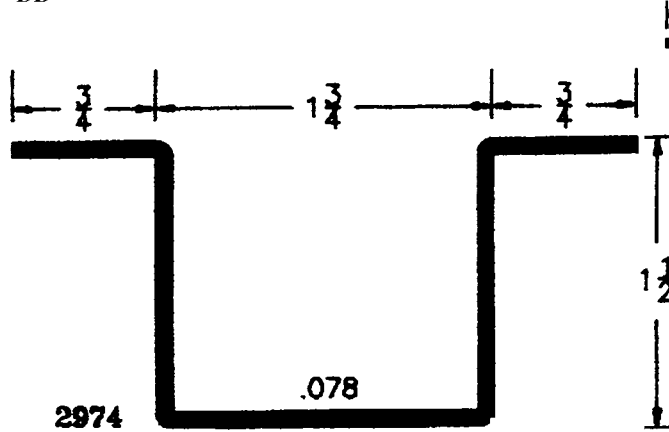
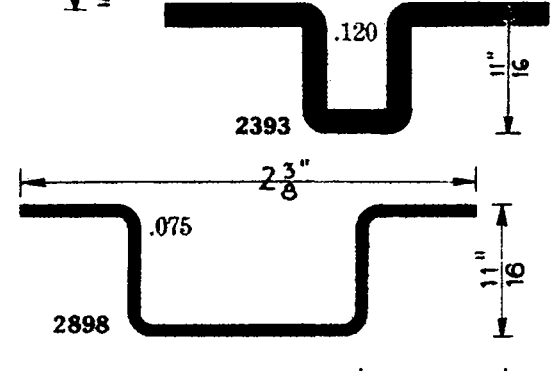
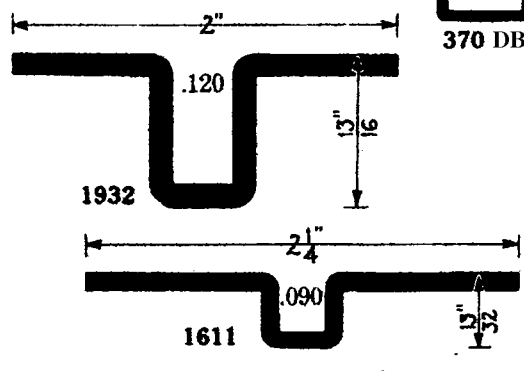
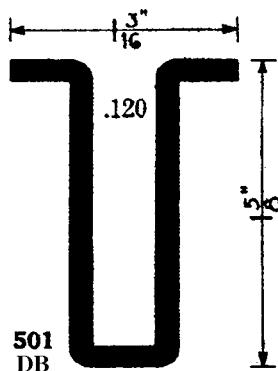
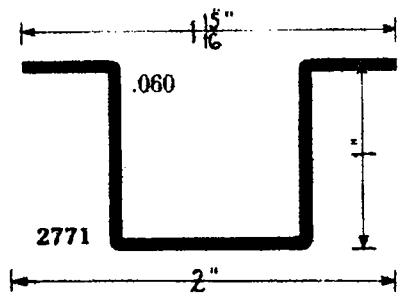
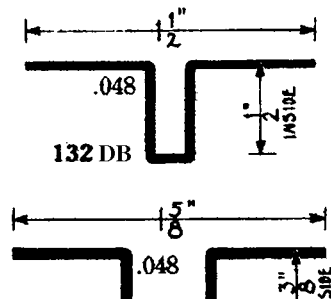
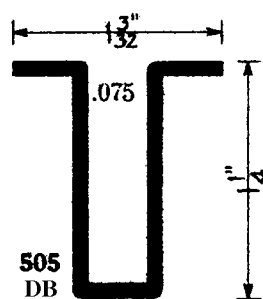
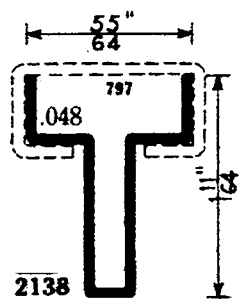

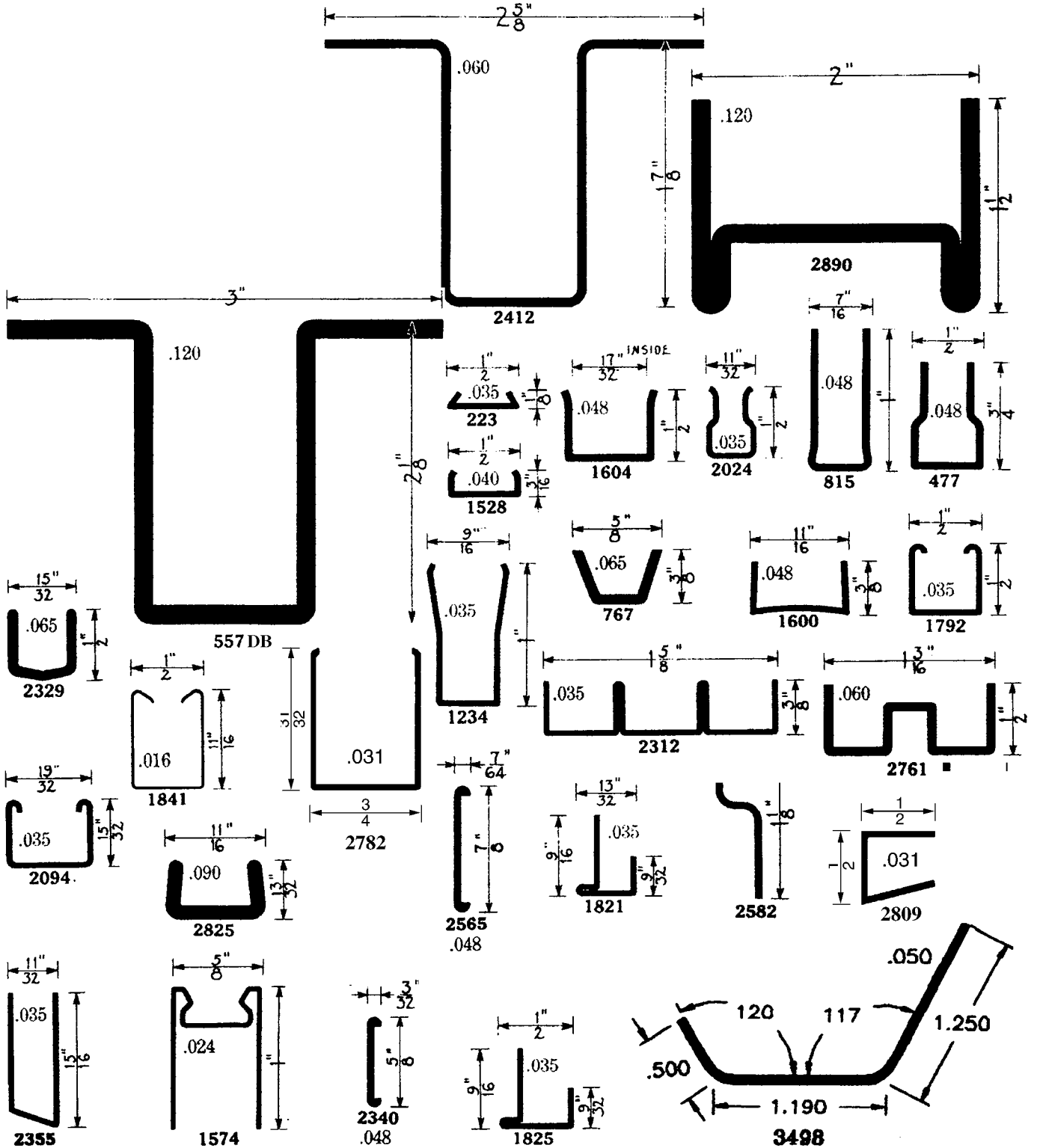
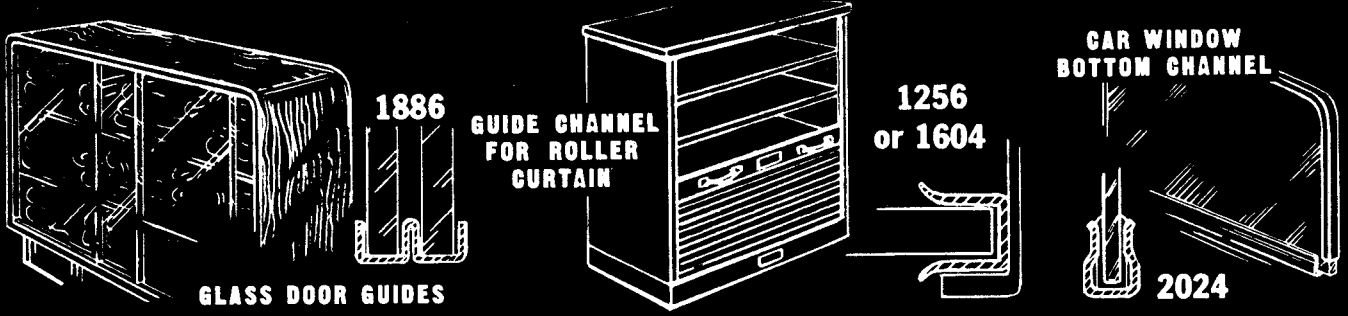

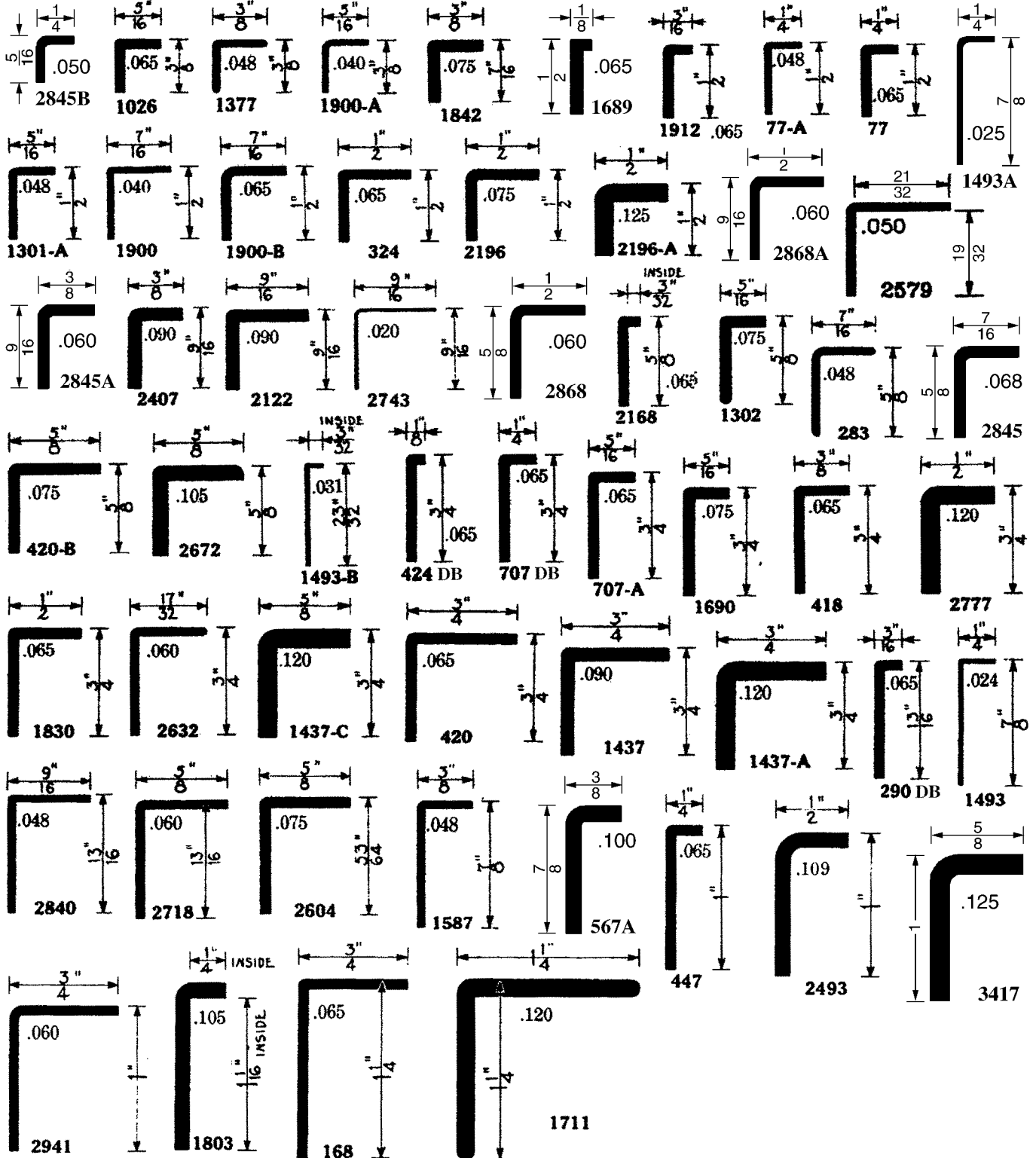
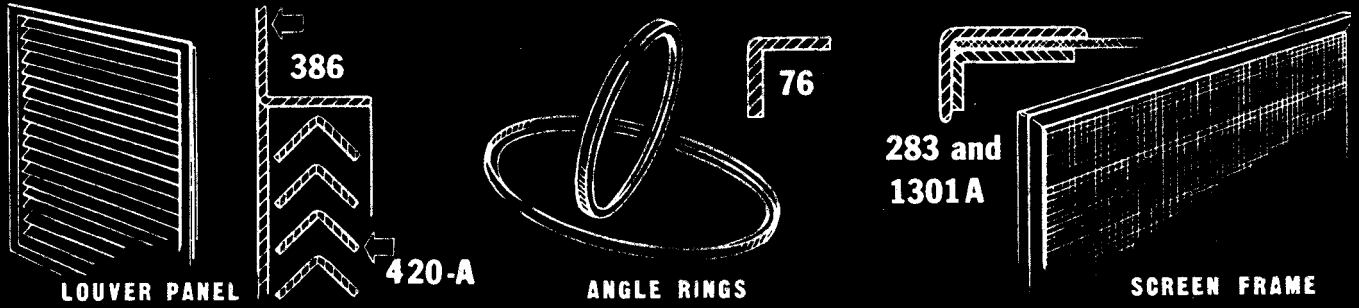

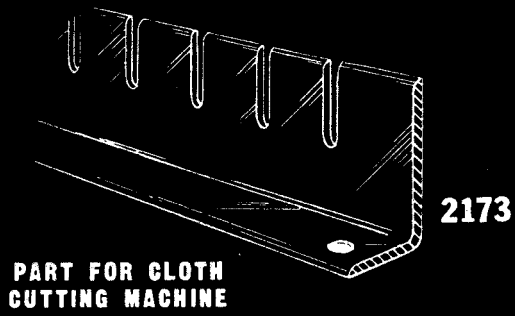

2173

PART FOR CLOTH CUTTING MACHINE

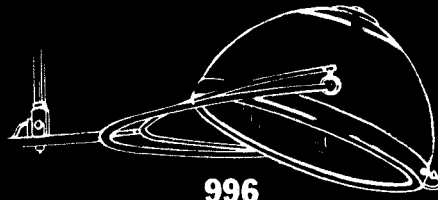

996

RING FOR OPERATING LIGHT

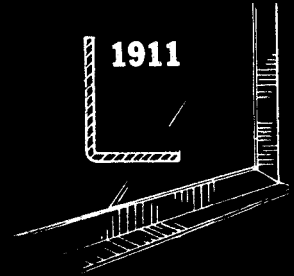

1911

CORNER CONSTRUCTION

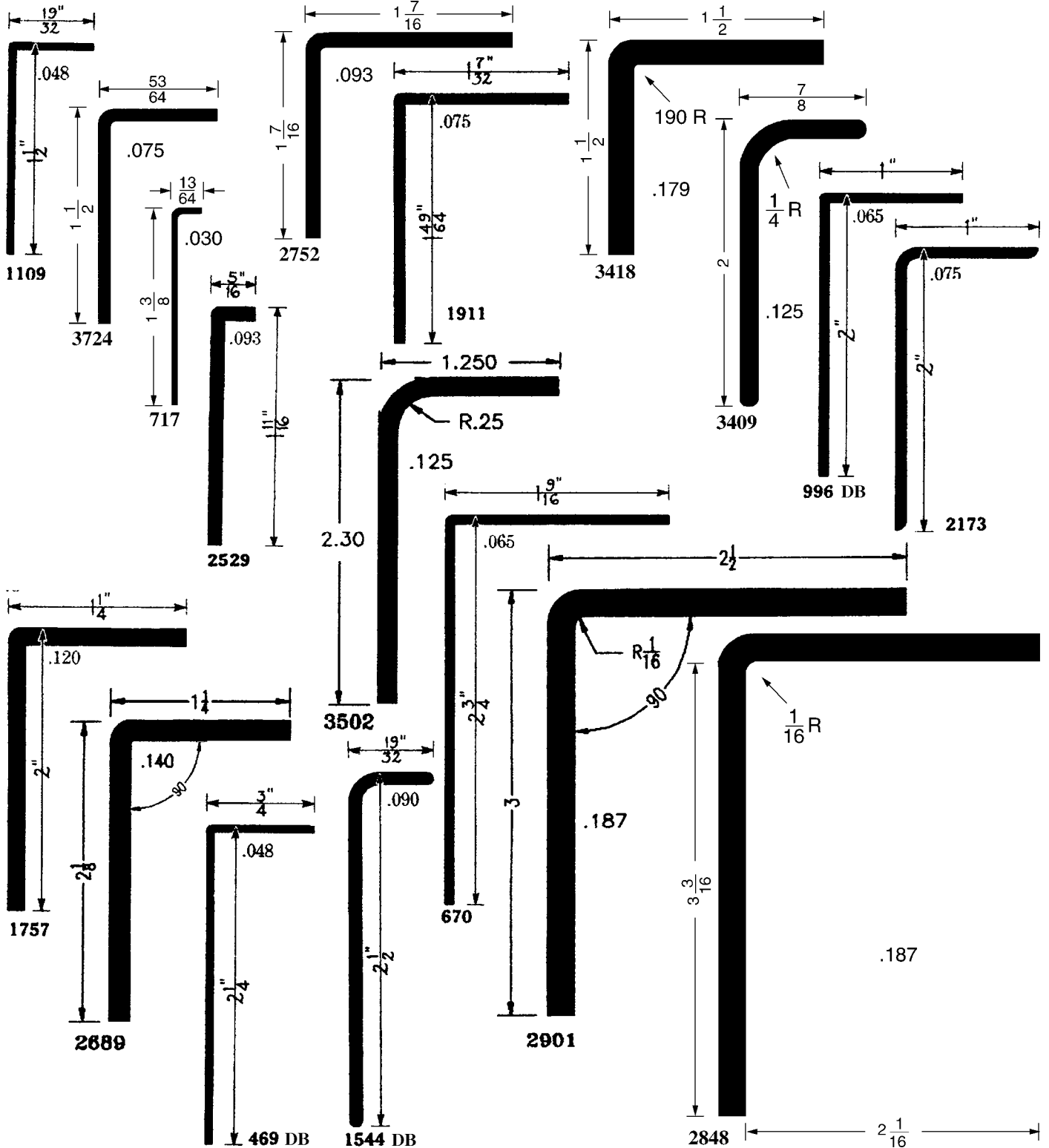



DESK BINDINGS

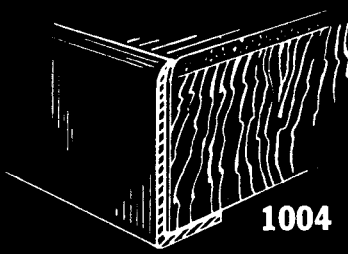

LINOLEUM BINDING

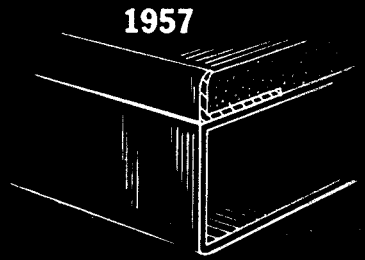

PANEL CONTROL BOARD

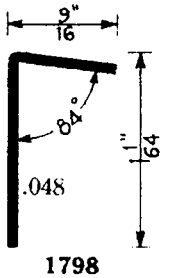
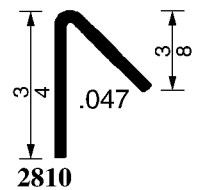
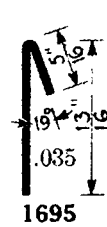
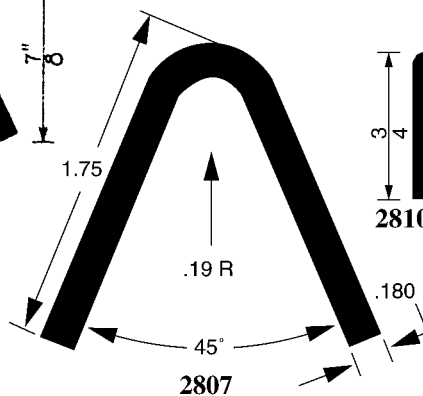
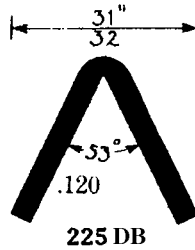
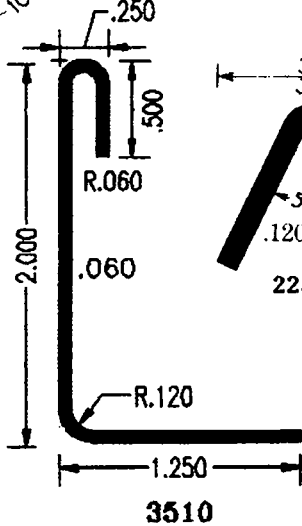
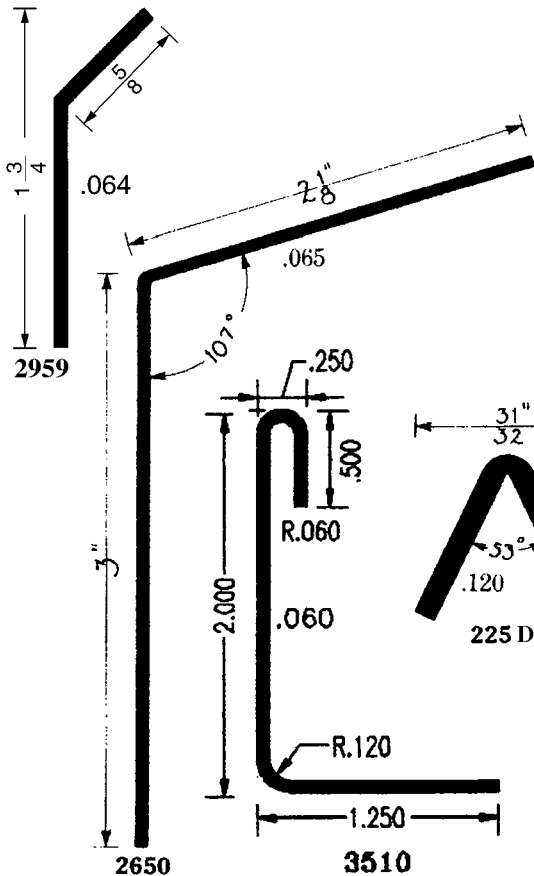
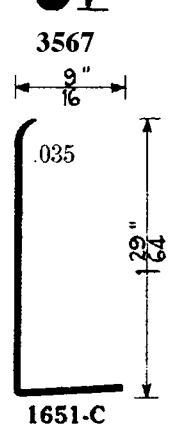
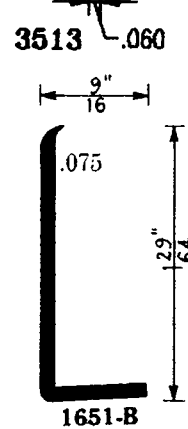
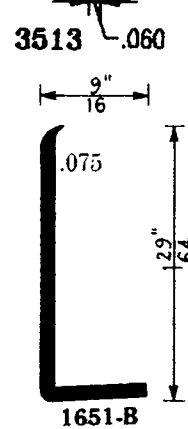
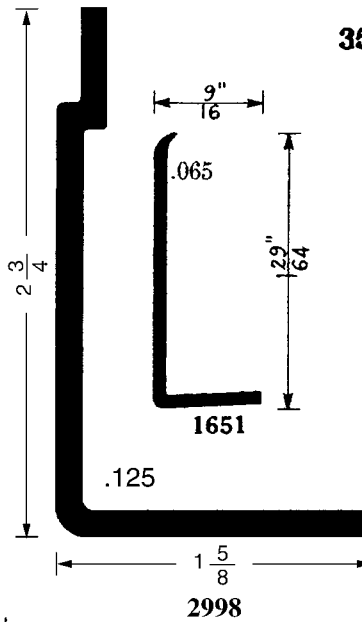
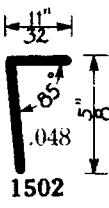
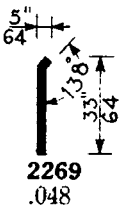
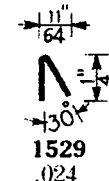
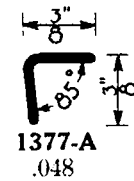
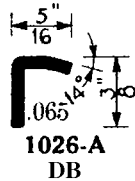
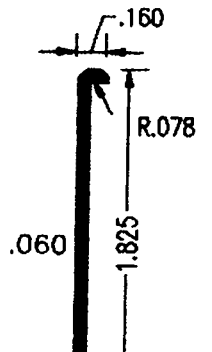
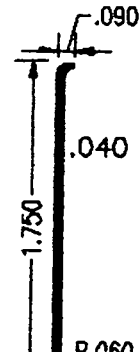
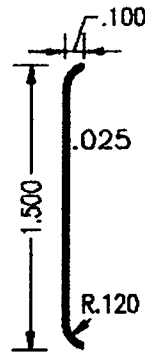
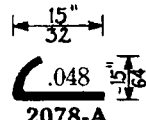
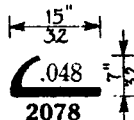
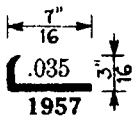

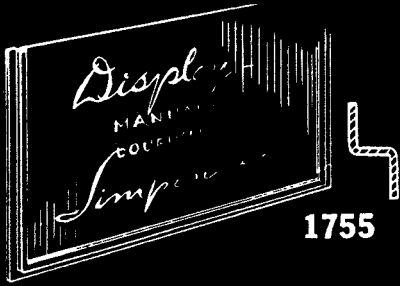

1755

DISPLAY CARD FRAME

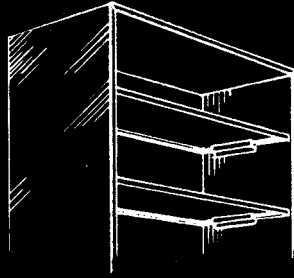

392A

SHELF STANDARDS

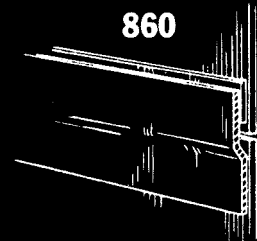

860

SPLICE JOINT

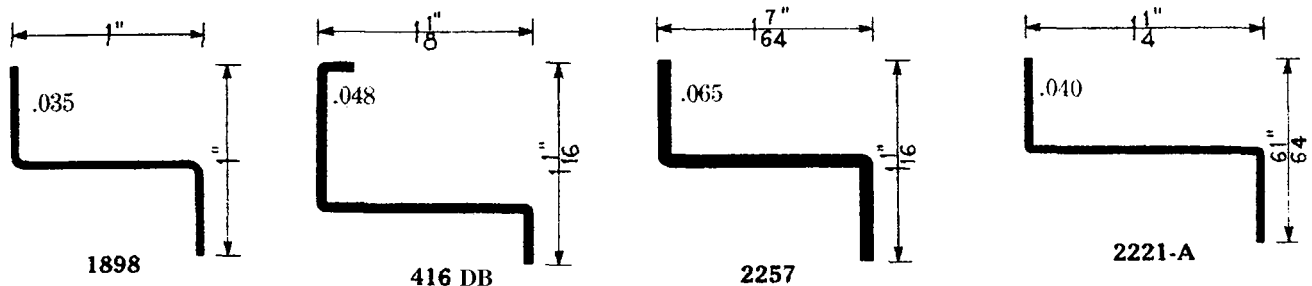
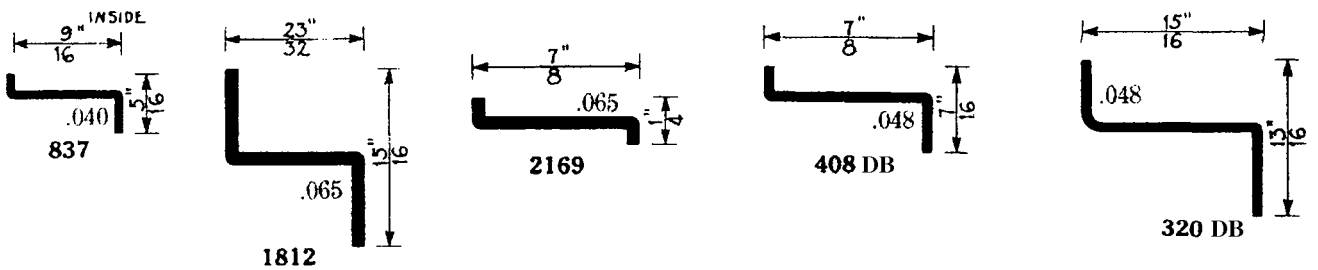
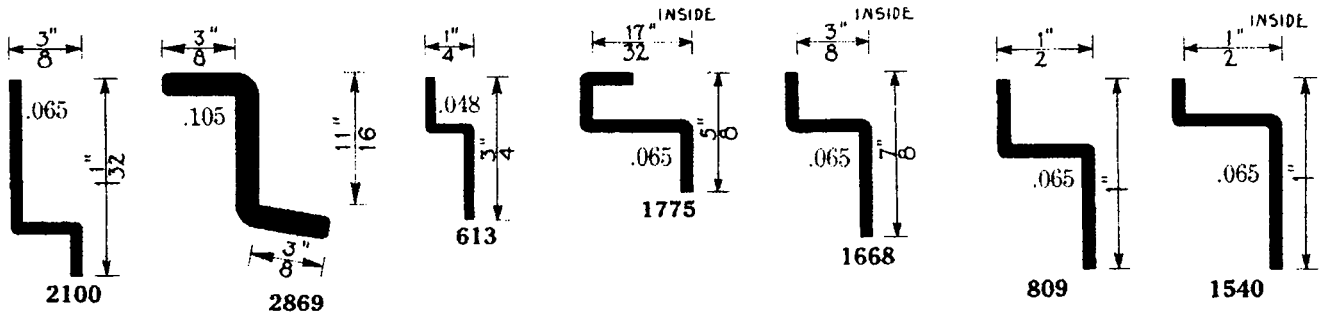
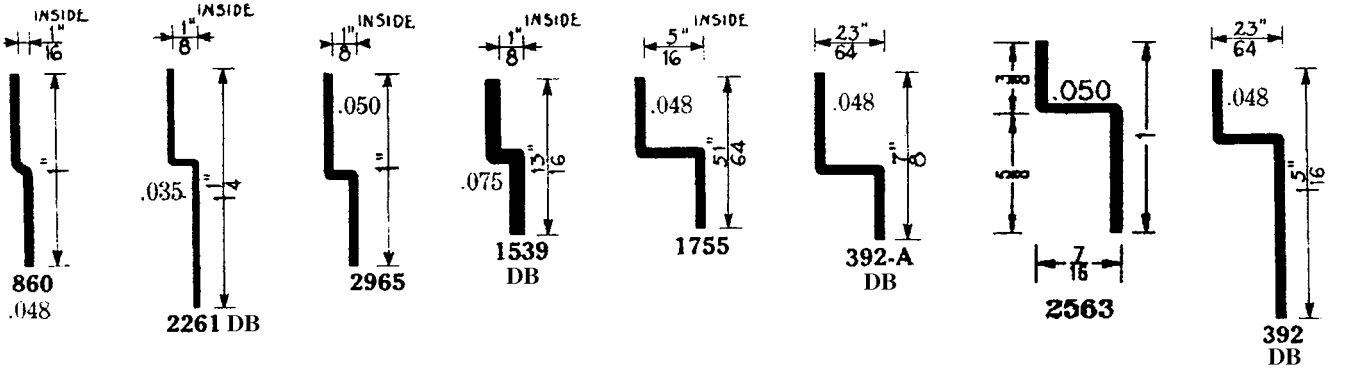

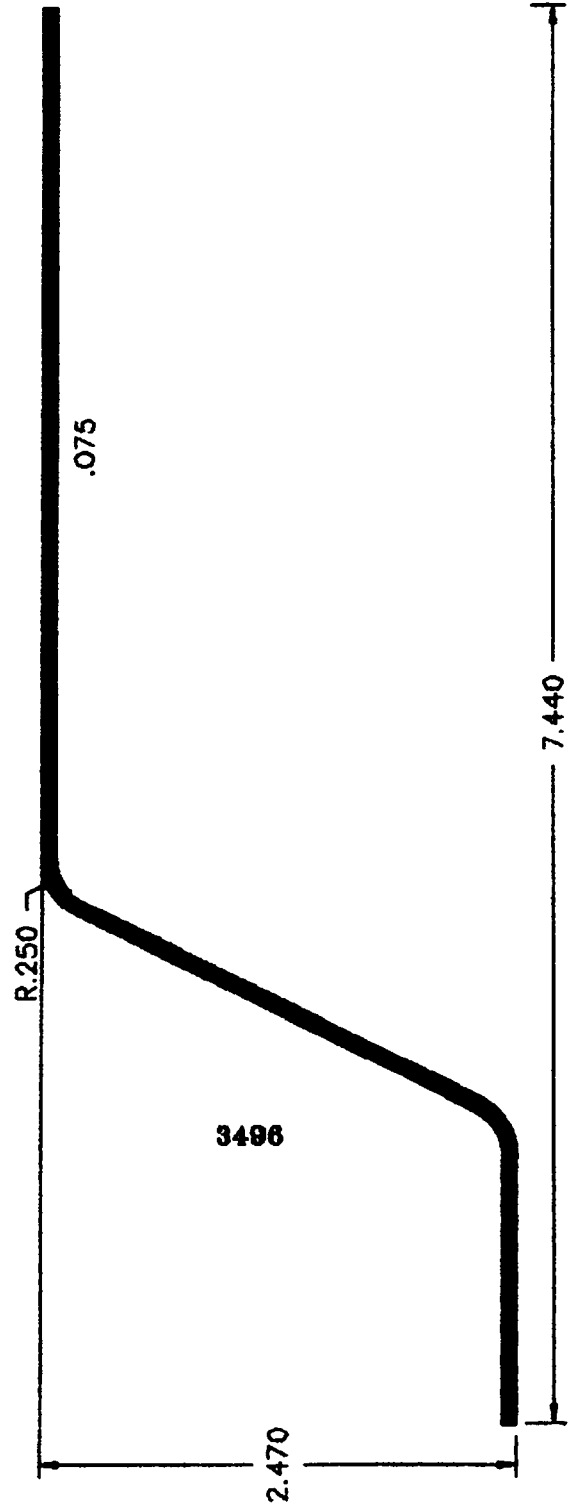
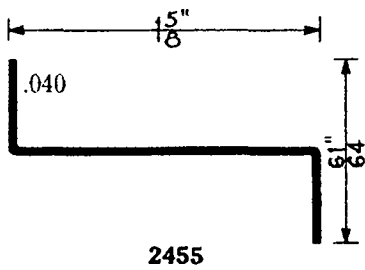
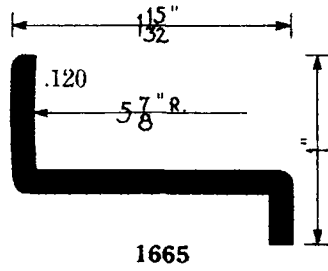
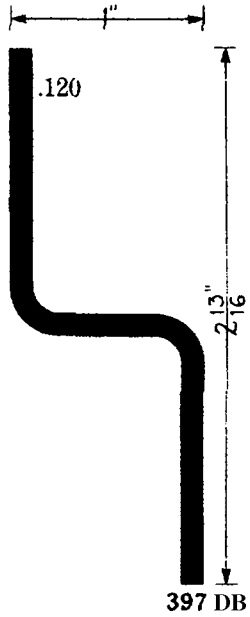
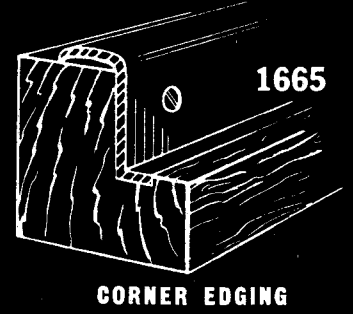
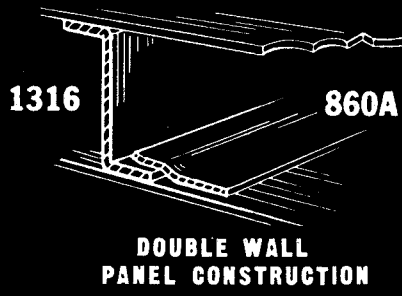
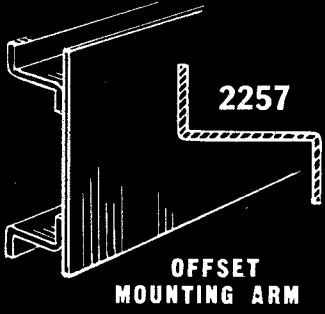

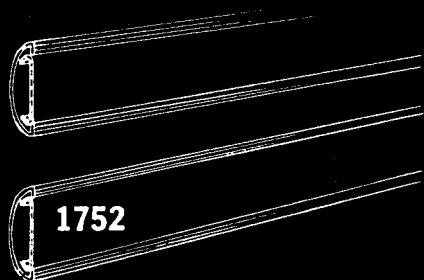

CLIPS FOR BEAD TRIM

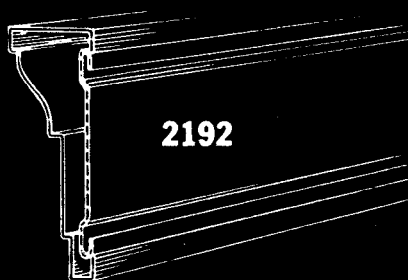

CASING CLIP

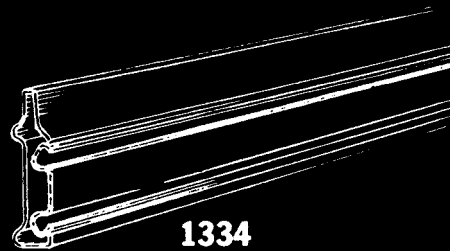

PICTURE MOULDING CLIP

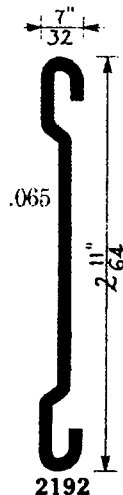
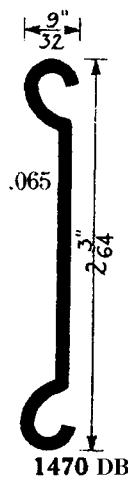
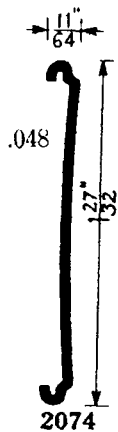
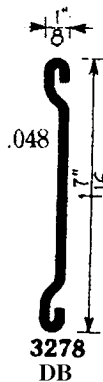
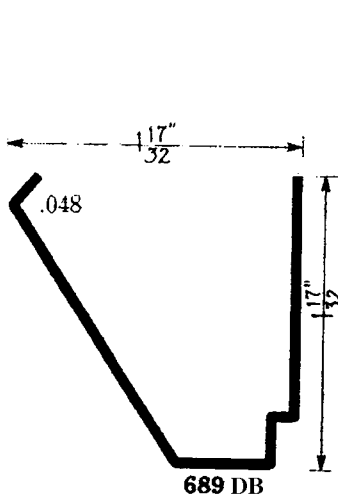
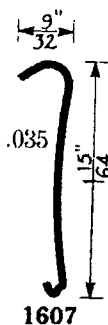
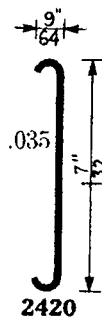
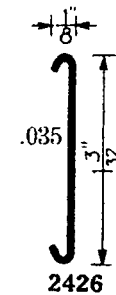
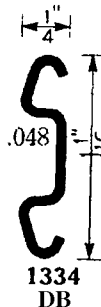
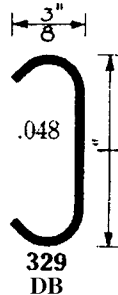
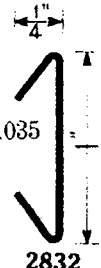
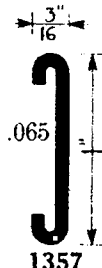
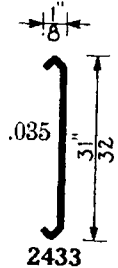
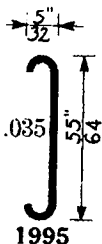
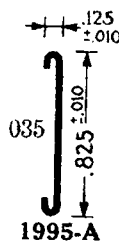
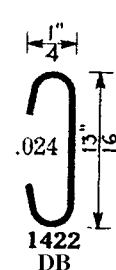
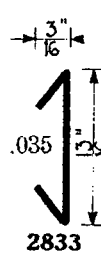
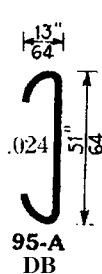
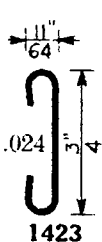
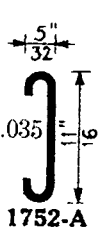
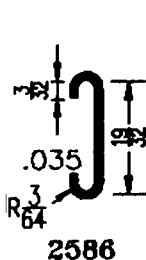
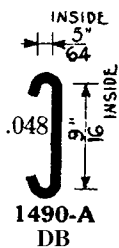
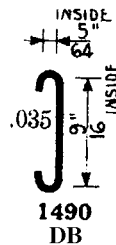
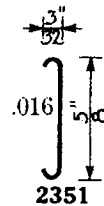
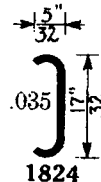
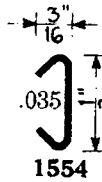
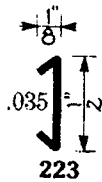
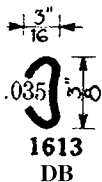
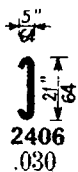
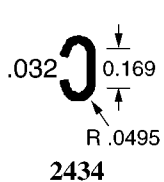

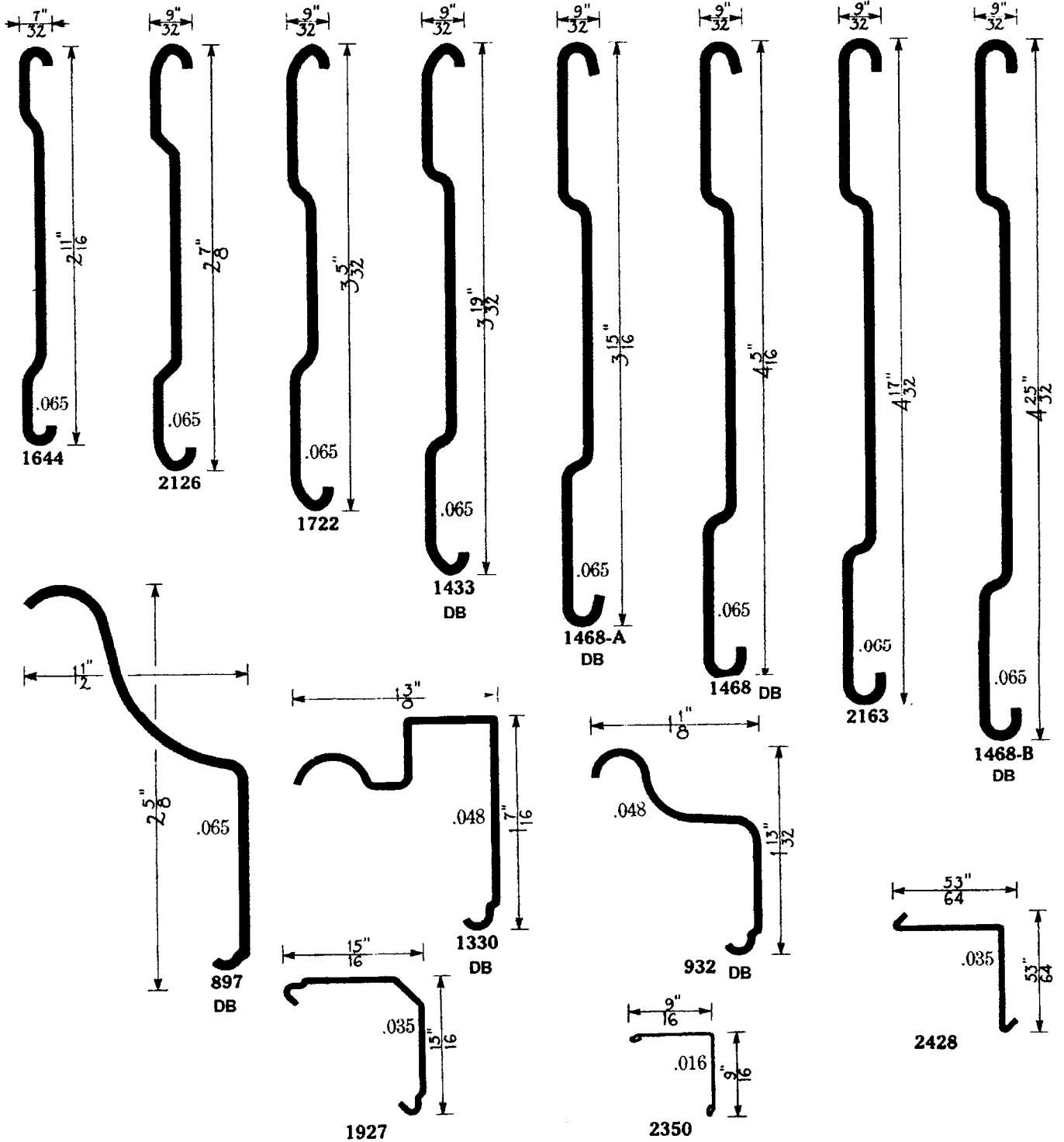
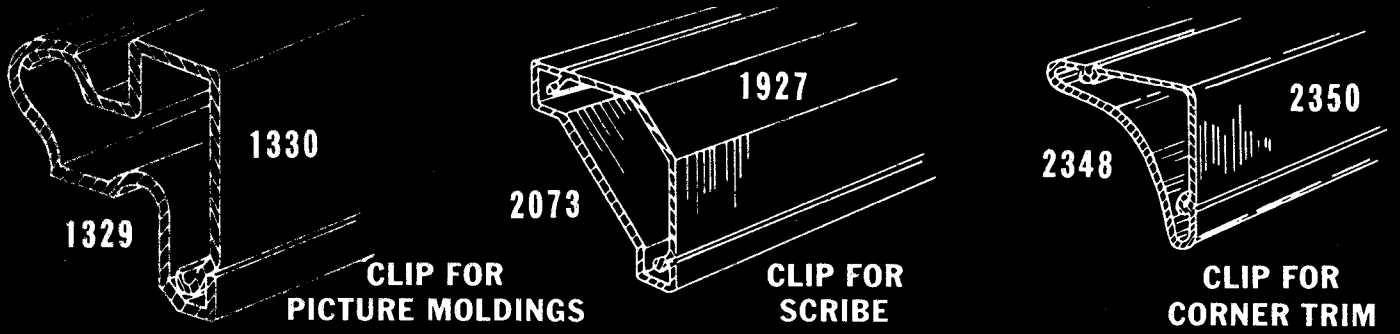



2448

EXPANSION JOINT

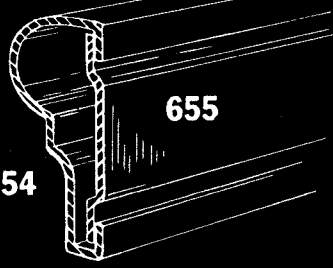

654

655

CLIP FOR BEAD TRIM

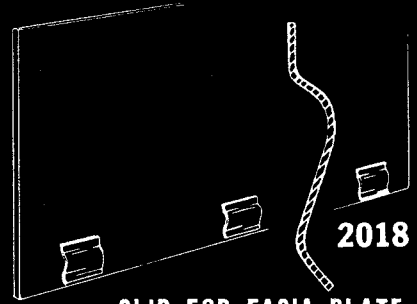

2018

CLIP FOR FACIA PLATE



2190

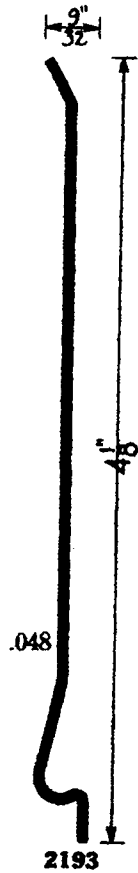

2193

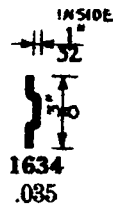

1634
.085

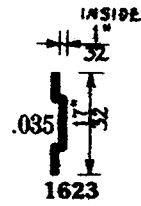

1623
.035



1834

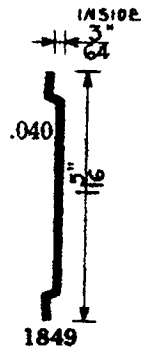

1849

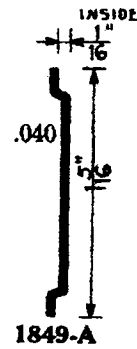

1849-A

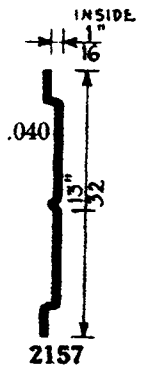

2157

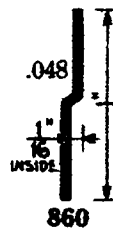

860

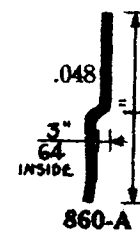

860-A

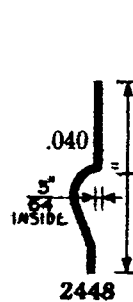

2448



2851

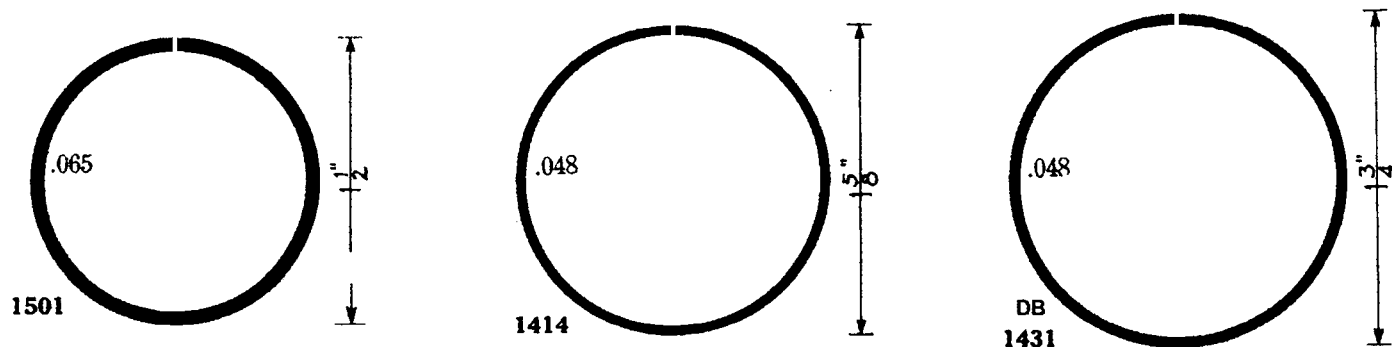
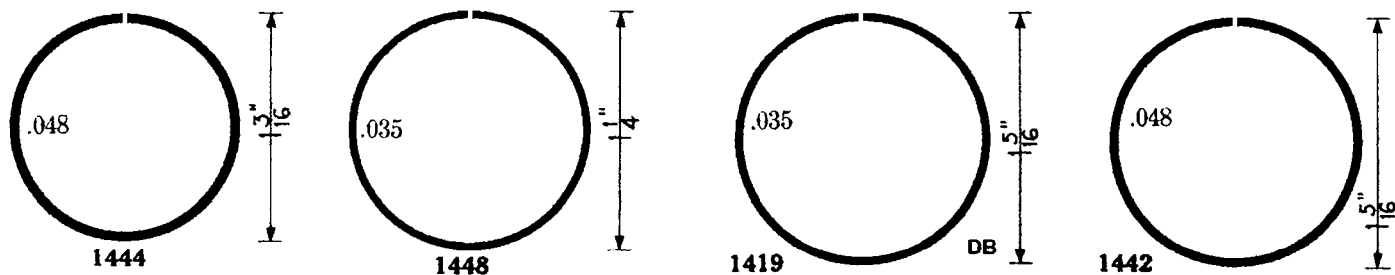
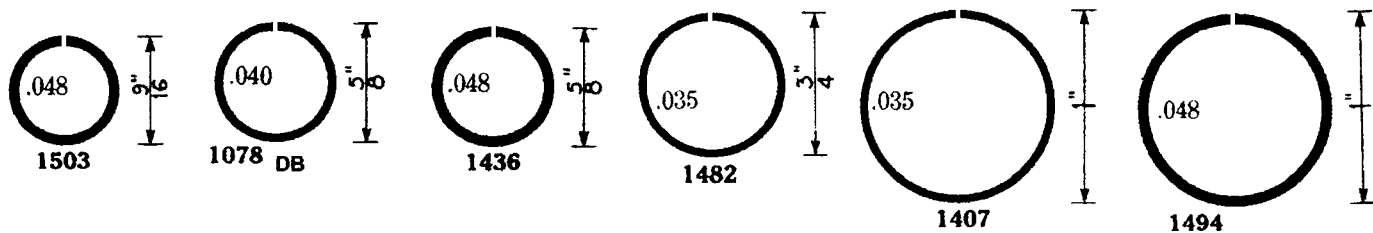
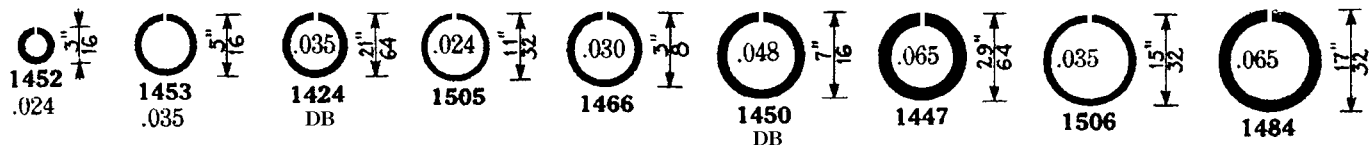
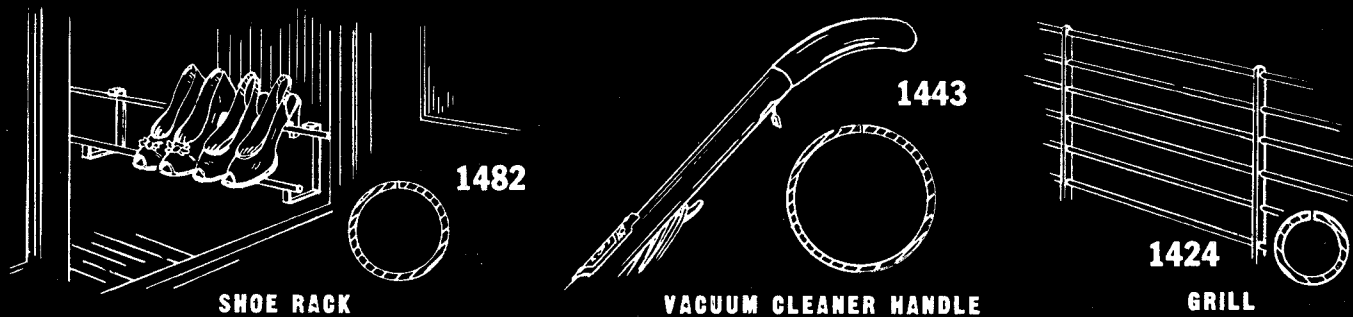

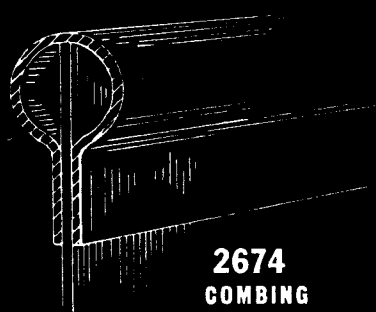

2674
COMBING

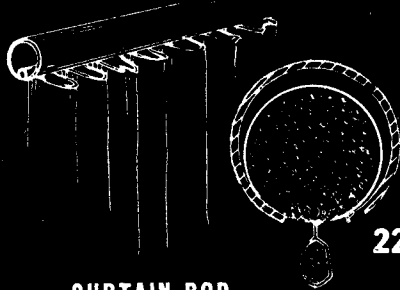

CURTAIN ROD

2222

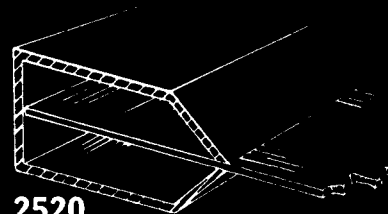

2520

PANEL CONSTRUCTION

