

SECTION TWO

- **PANEL PROFILES**
- **GLASS STOPS**
- **SCRIBES**
- **BASE PROFILES**
- **SYMMETRICAL TRIM**
- **BEAD SHAPES**
- **INSERTS**

This section also includes decorative trim shapes suitable for recessed inserts. Shallow box channels and bead shapes can also be used for inserts. See pages 9, 11 and 77.

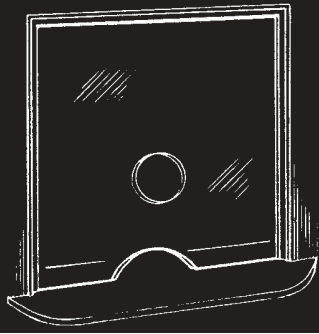

796

**CLIP-ON TRIM
TICKET WINDOW**

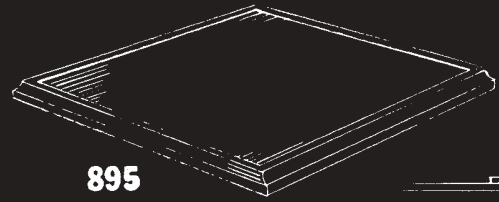

895

COVER CONSTRUCTION

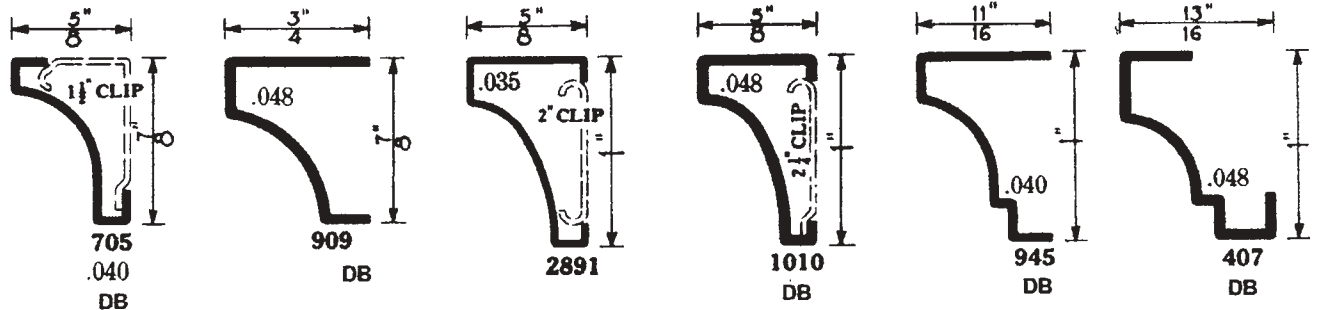
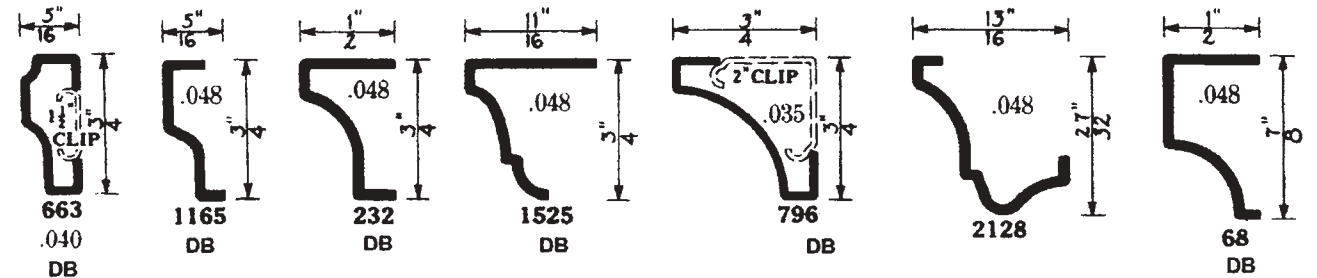
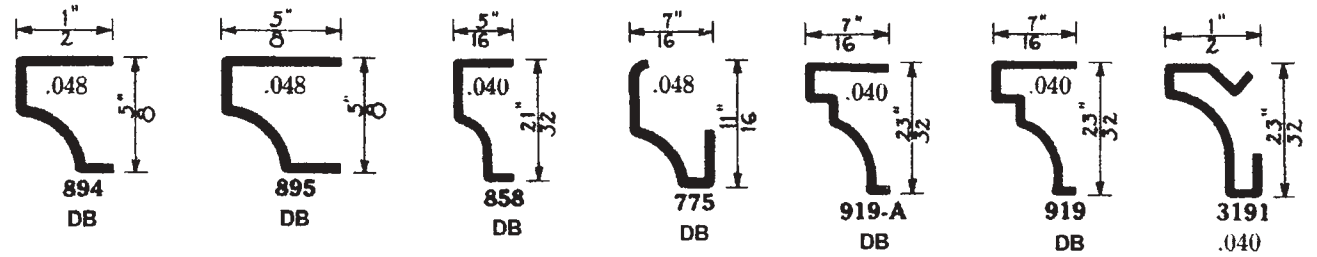
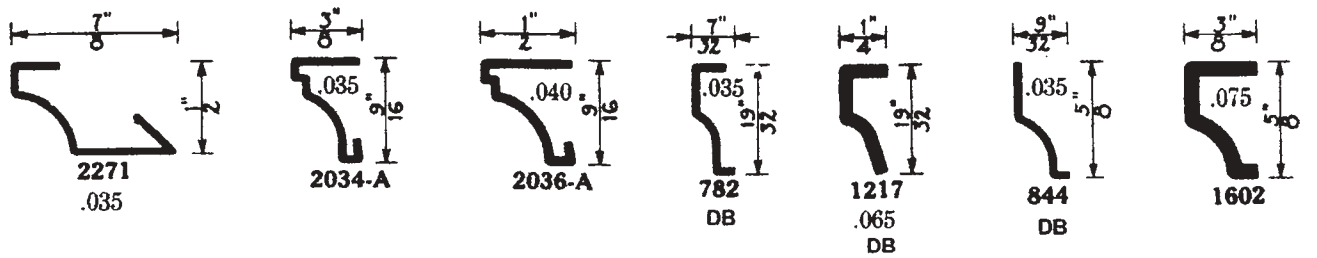
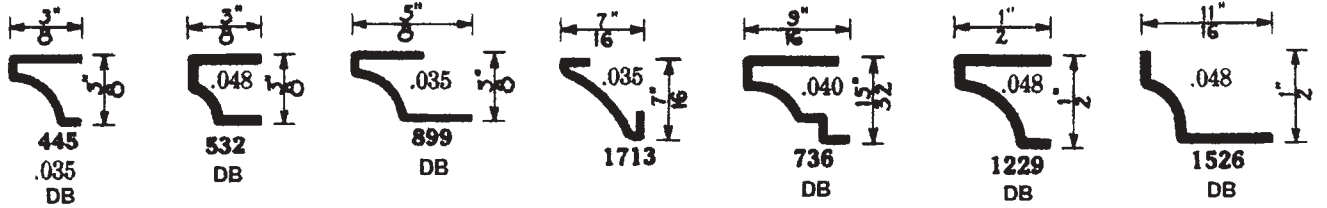

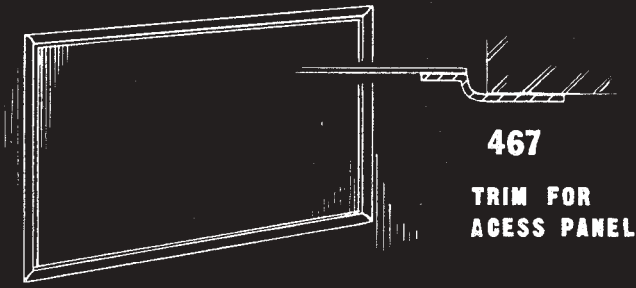

467
TRIM FOR
ACCESS PANEL

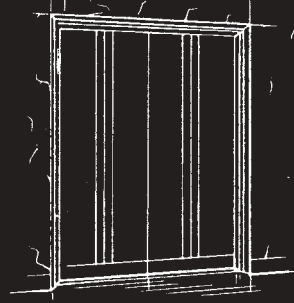

945
SCREW-ON
TRIM WITH
MARBLE WALL

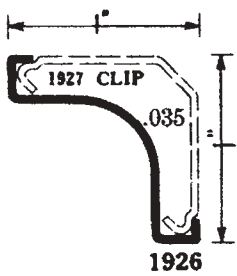

1926

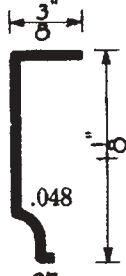

67
DB

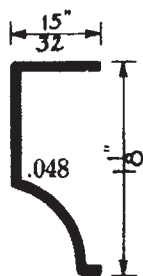

788
DB

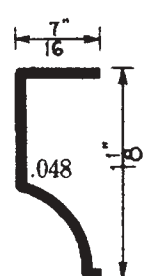

788-A
DB

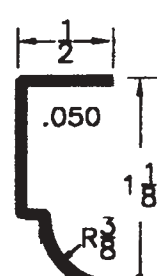

262
DB

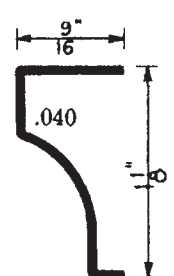

474
DB

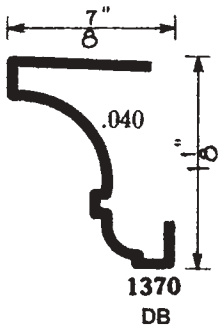

1370
DB

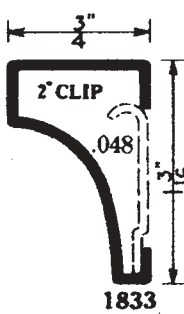

1833

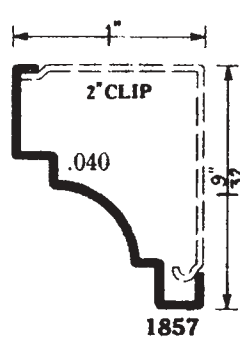

1857

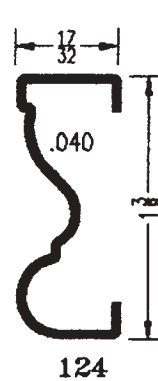

124

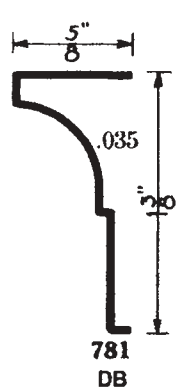

781
DB

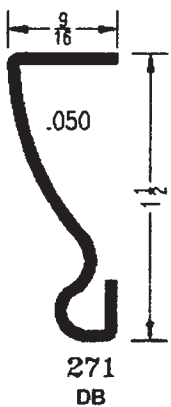

271
DB

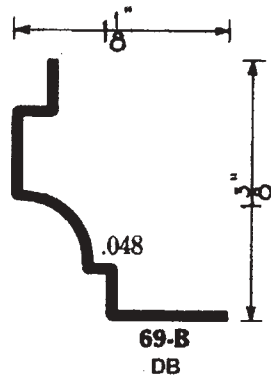

69-B
DB

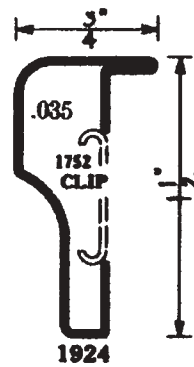

1924

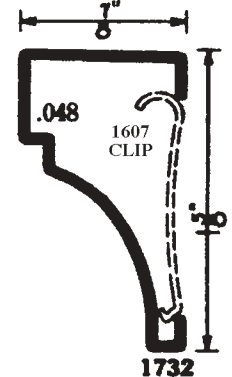

1732

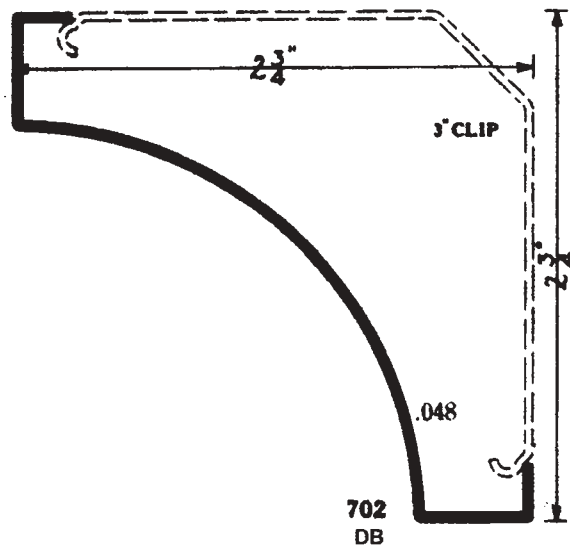
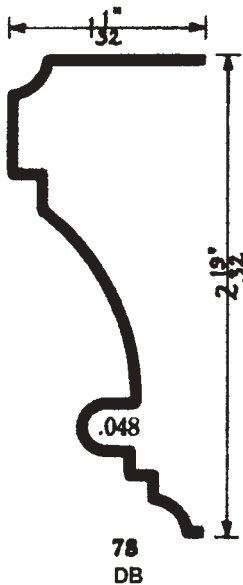
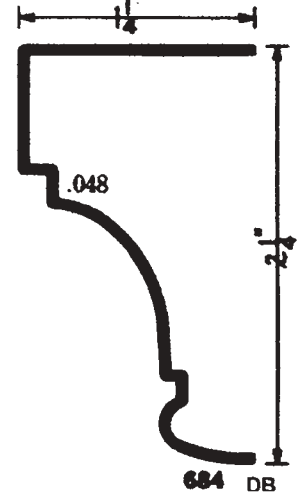
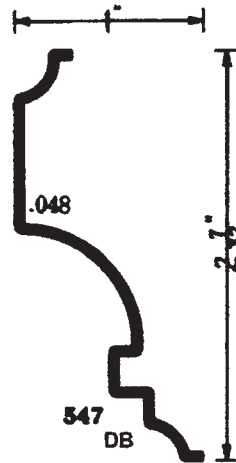
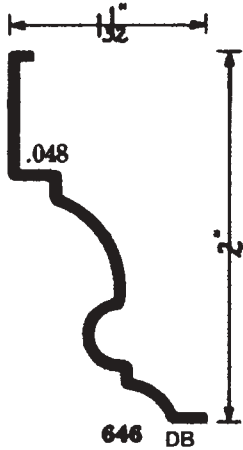
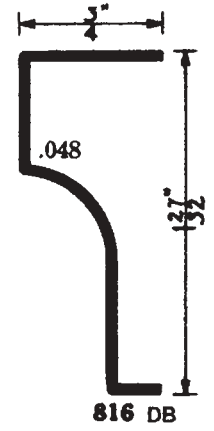
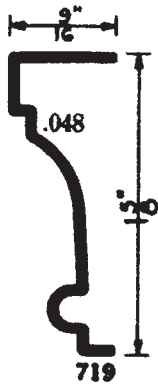
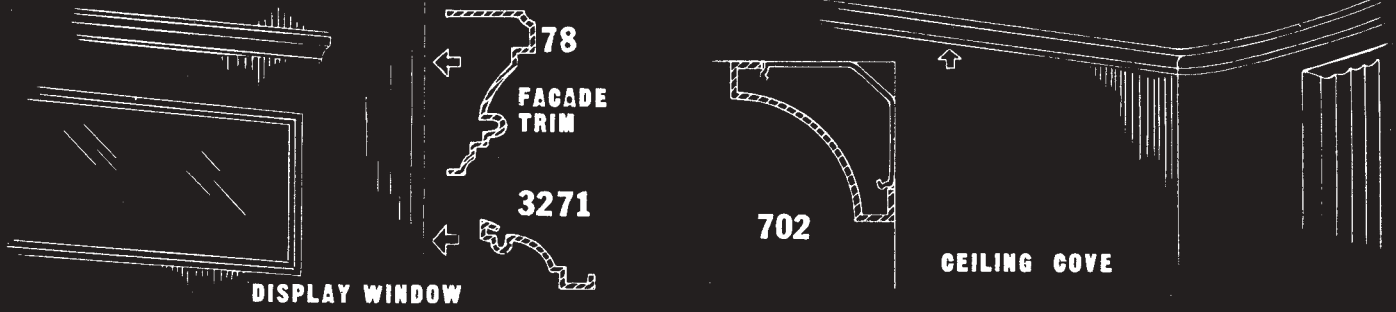

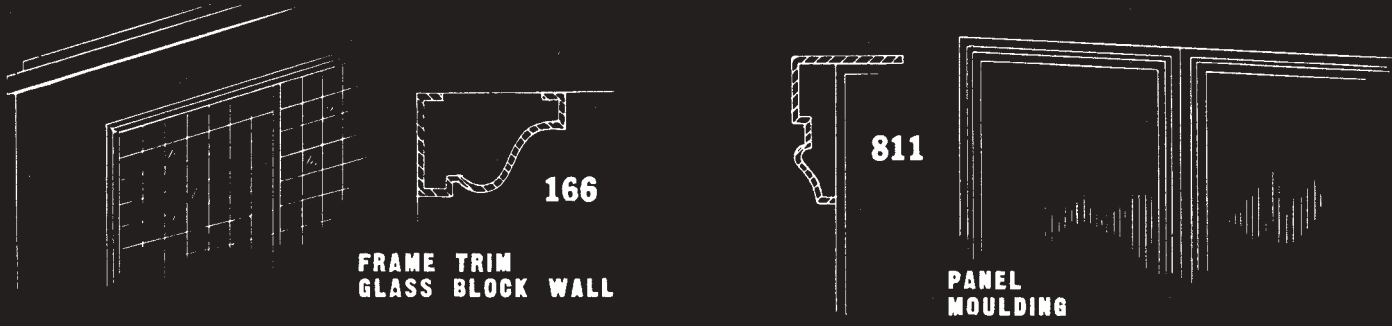

FRAME TRIM
GLASS BLOCK WALL

PANEL
MOULDING

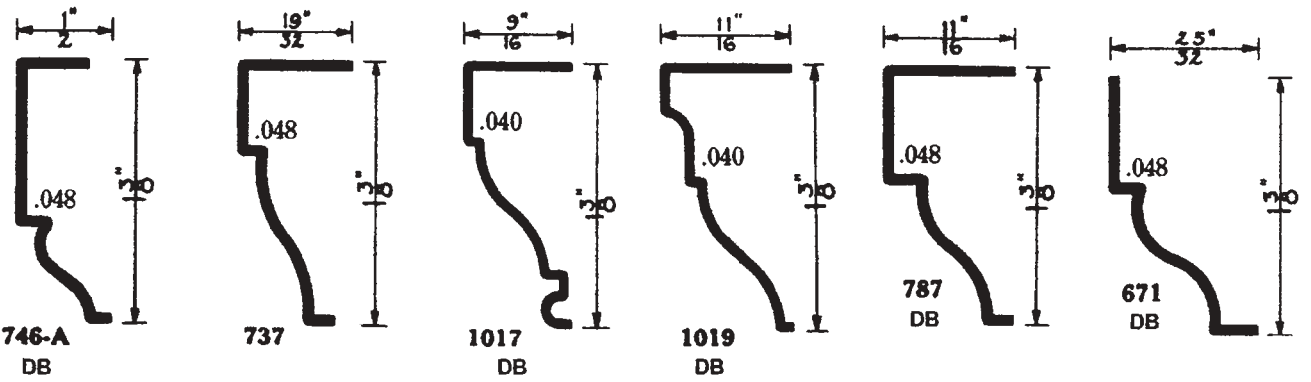
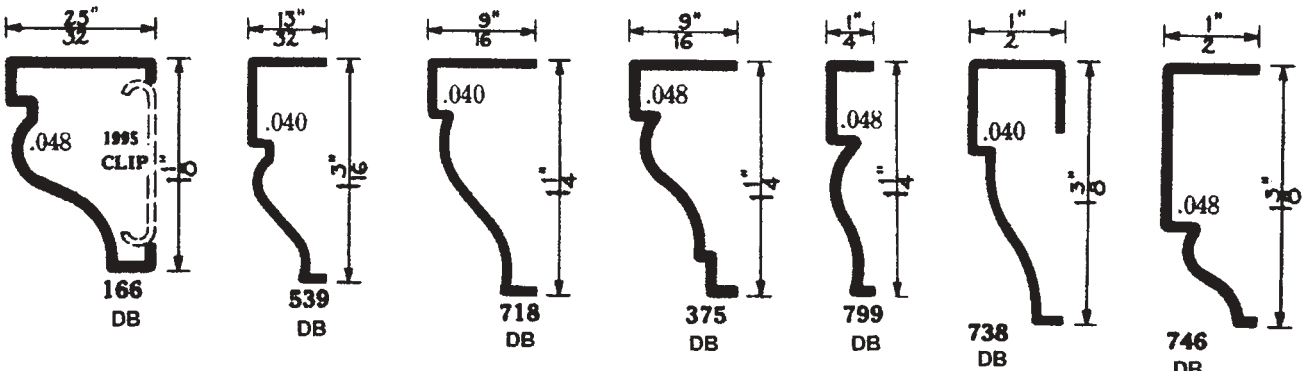
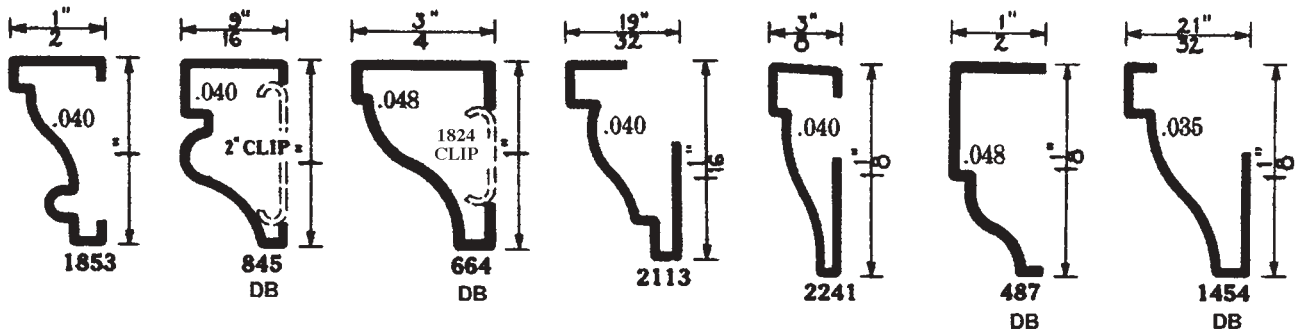
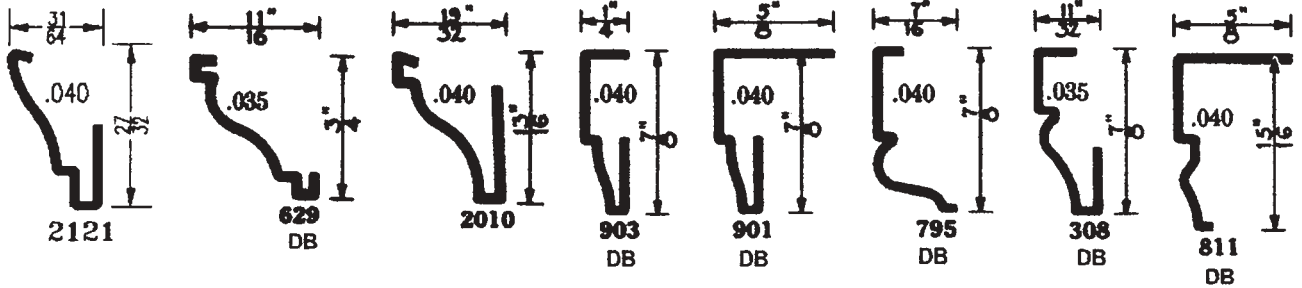

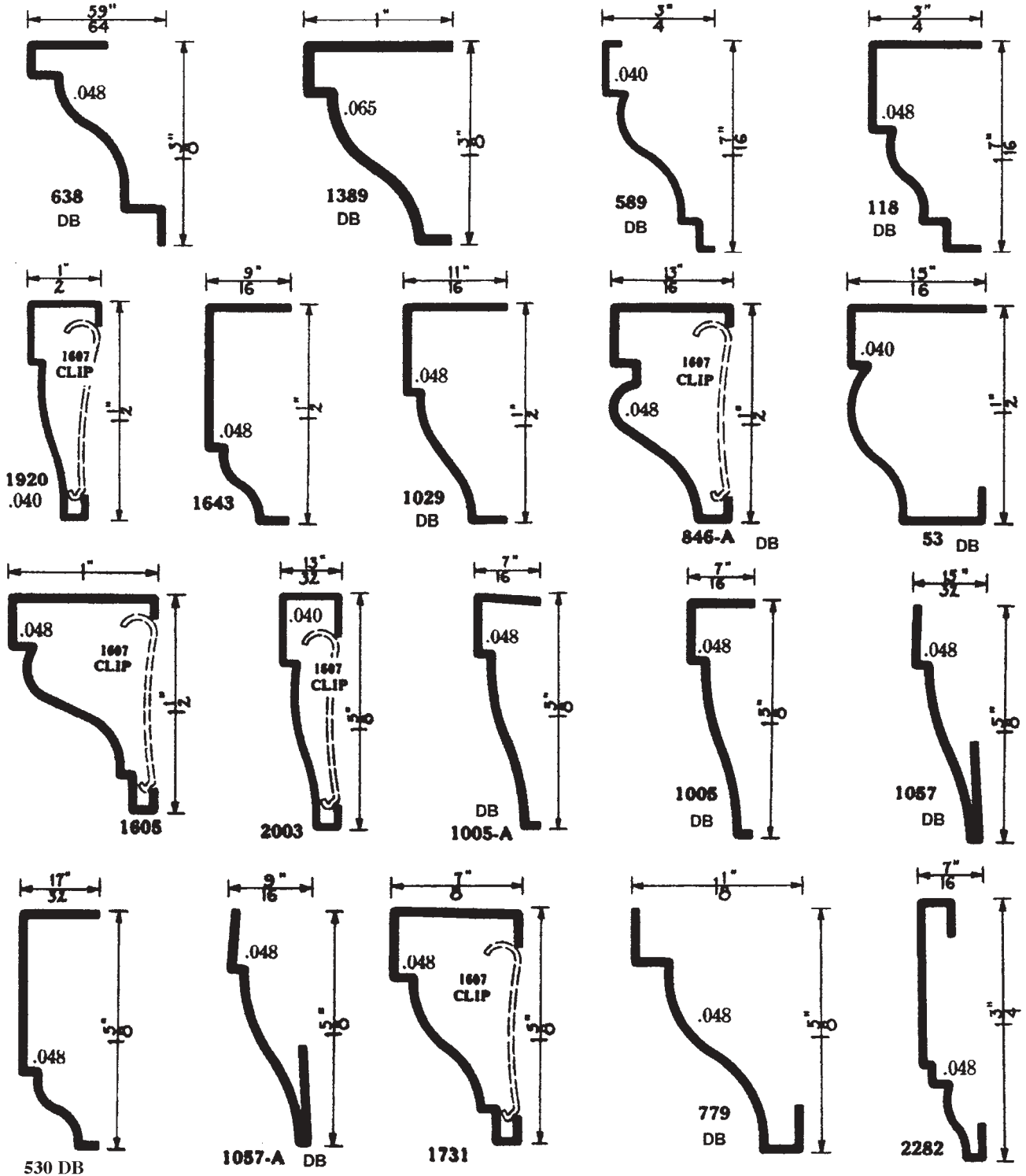
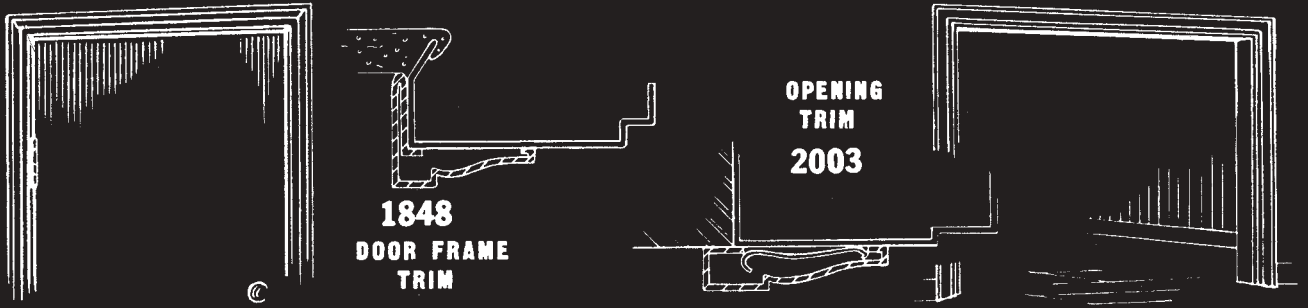

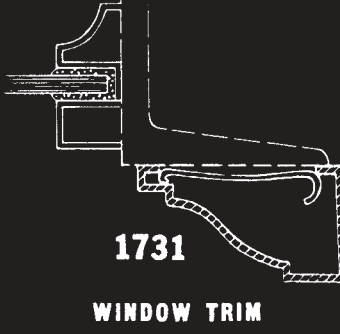
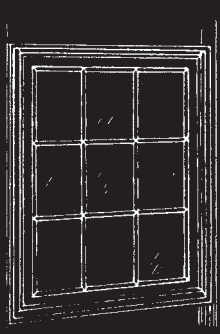

1731
WINDOW TRIM

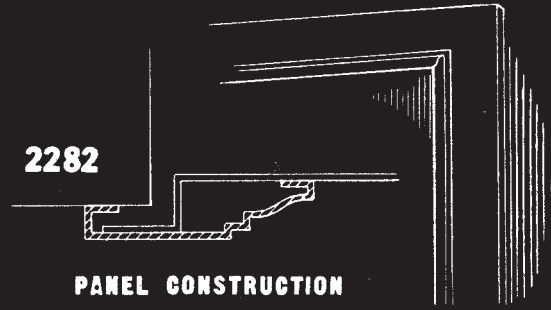

2282
PANEL CONSTRUCTION

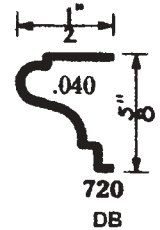
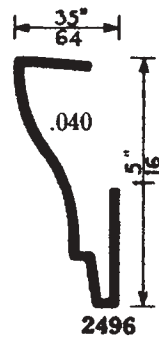
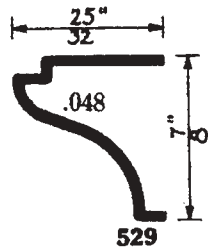
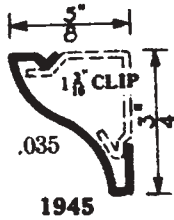
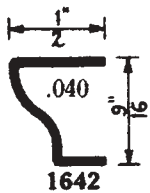
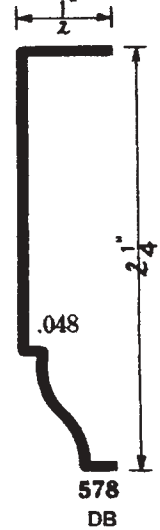
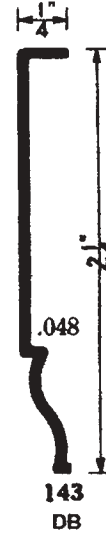
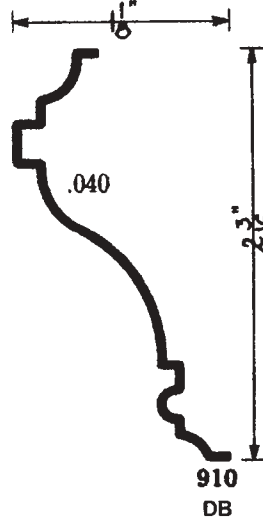
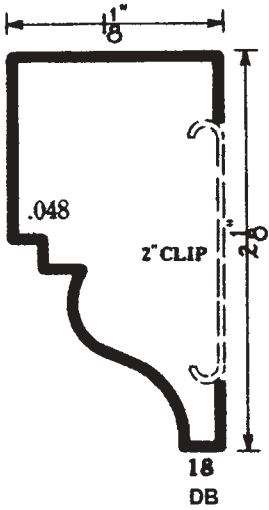
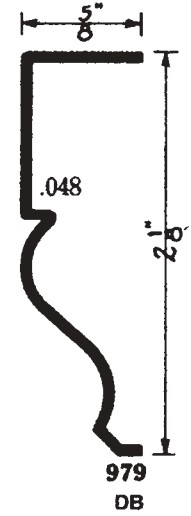
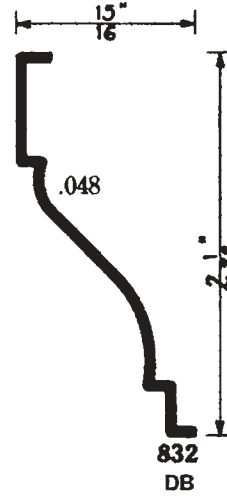
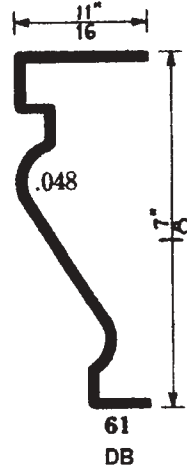
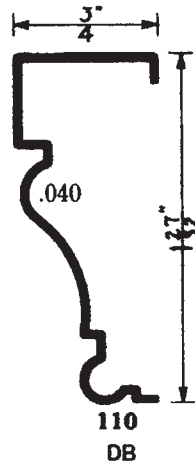
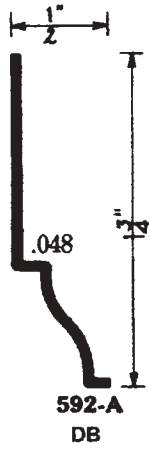
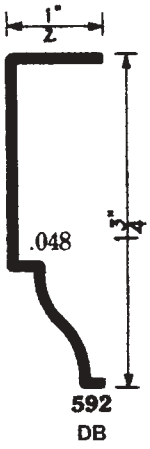

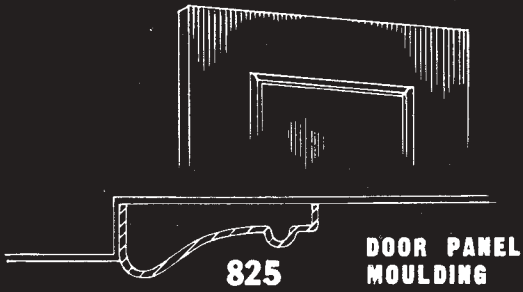

**DOOR PANEL
MOULDING**

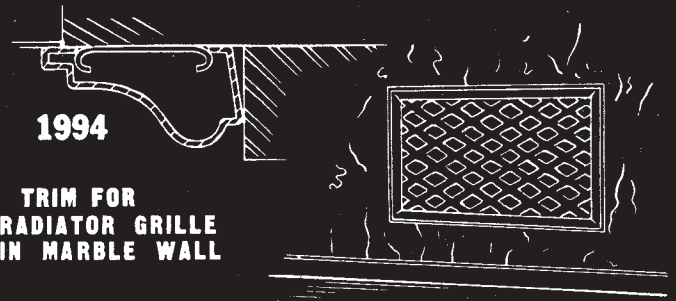

1994
**TRIM FOR
RADIATOR GRILLE
IN MARBLE WALL**



**38
DB**



**653
DB**



**277
DB**

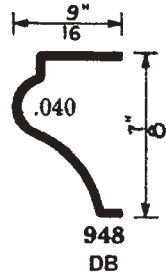

**948
DB**

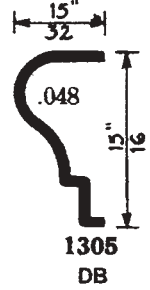

**1305
DB**

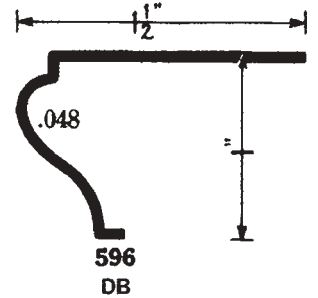

**596
DB**

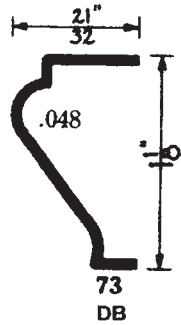

**73
DB**



**825
DB**

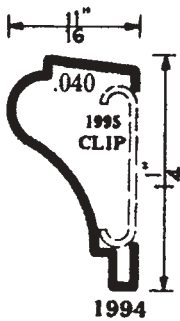

1994



54

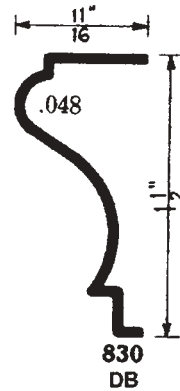

**830
DB**

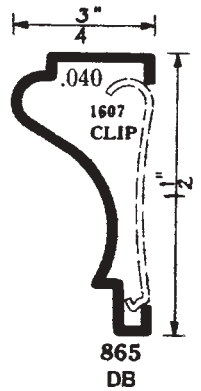

**865
DB**

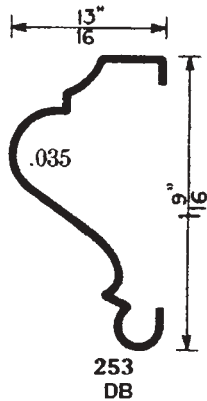

**253
DB**

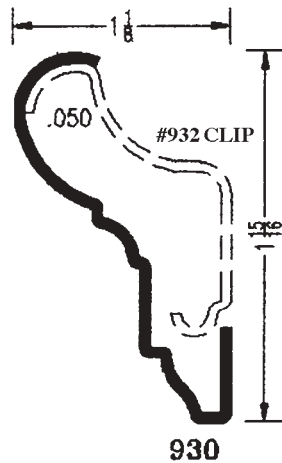

930

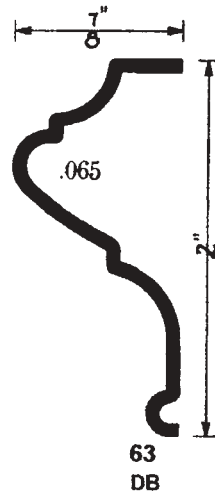

**63
DB**

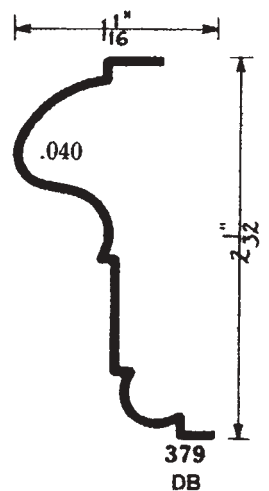

**379
DB**



1980

SCRIBE TRIM
RECESSED OPENING

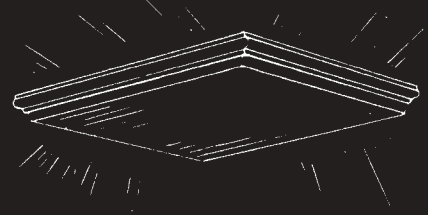
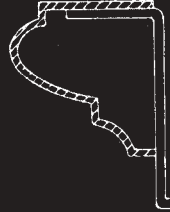

997

INDIRECT
LIGHTING FIXTURE

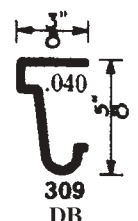
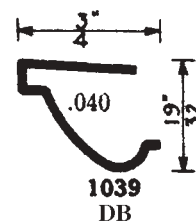
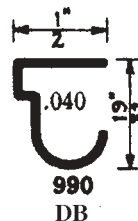
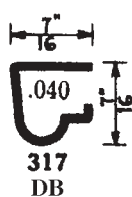
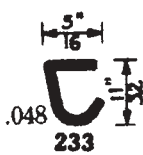
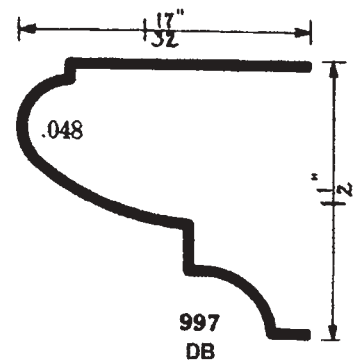
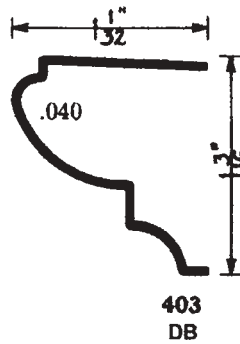
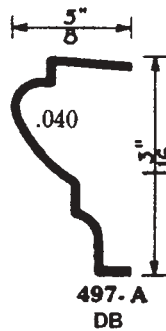
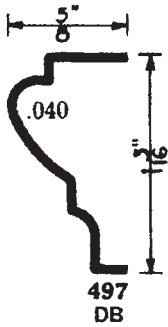
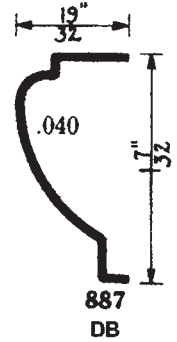
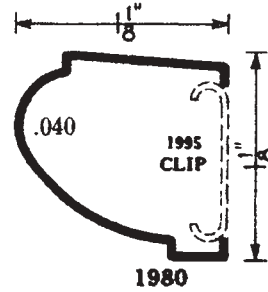
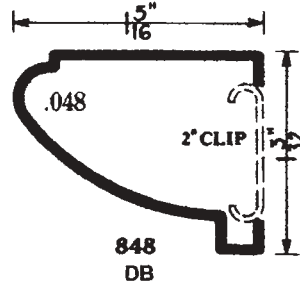
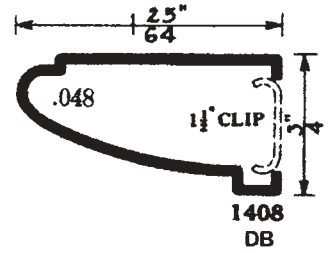
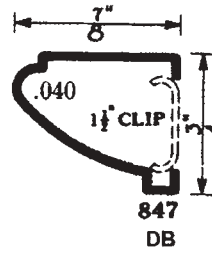
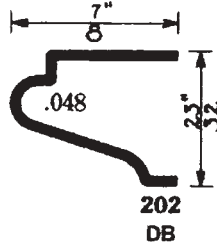
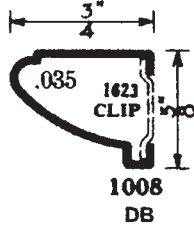
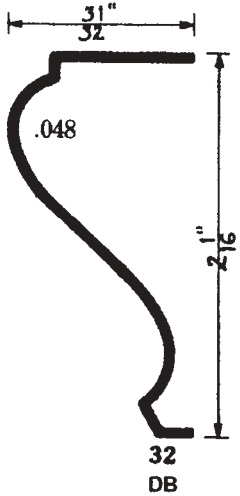

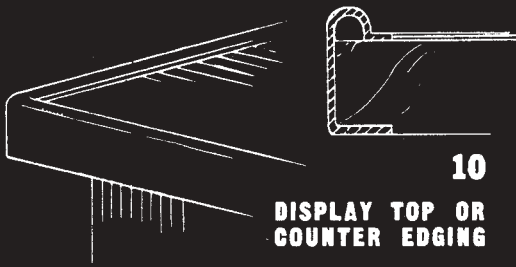

10

DISPLAY TOP OR
COUNTER EDGING



990

METAL TRIM
FOR VISION PANEL

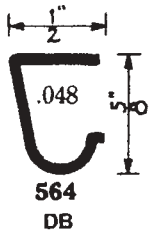
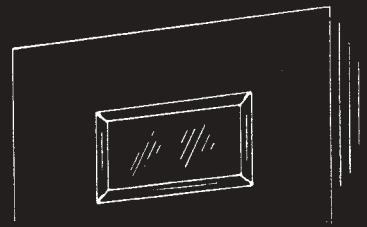

564
DB

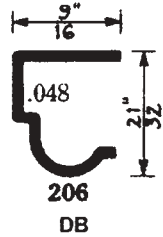

206
DB

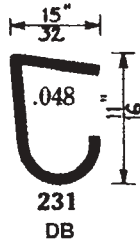

231
DB

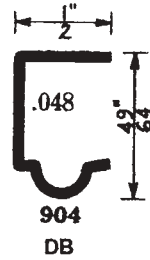

904
DB

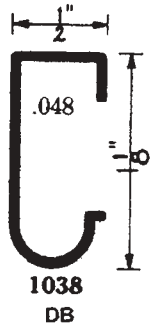

1038
DB

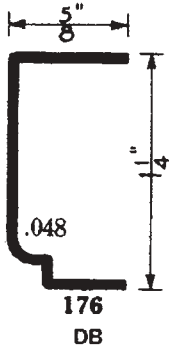

176
DB

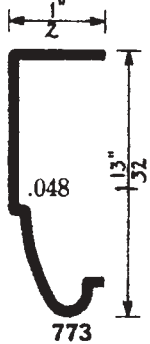

773



1012
DB

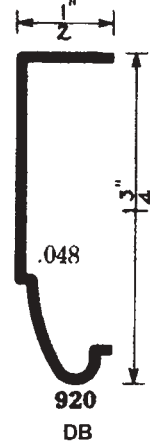

920
DB



1013
DB

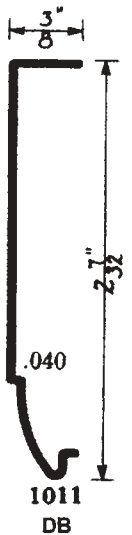

1011
DB

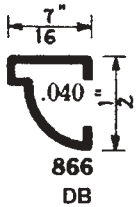

866
DB

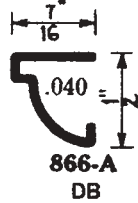

866-A
DB



1009
DB



1961-A

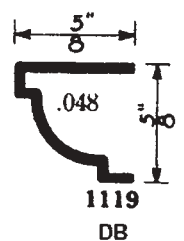

1119
DB

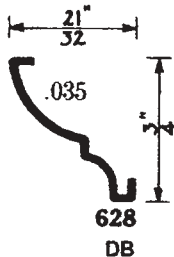

628
DB

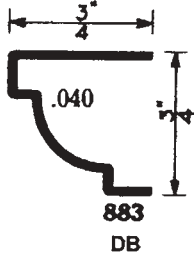

883
DB

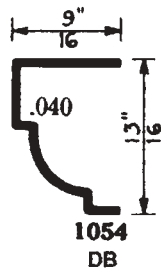

1054
DB

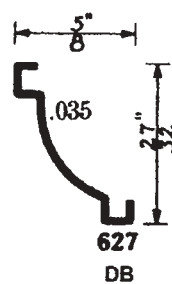

627
DB

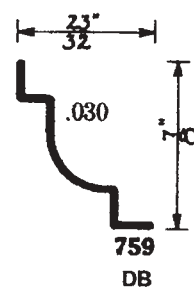

759
DB

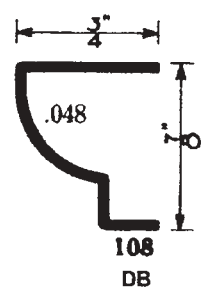

108
DB

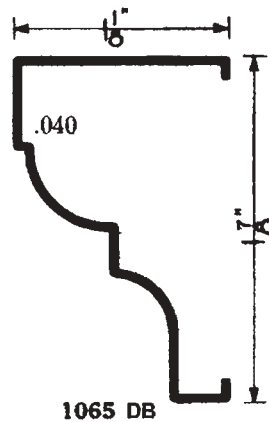
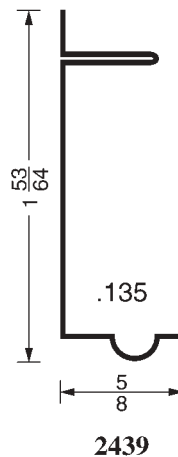
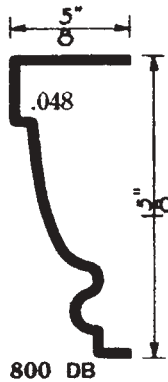
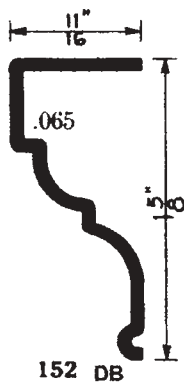
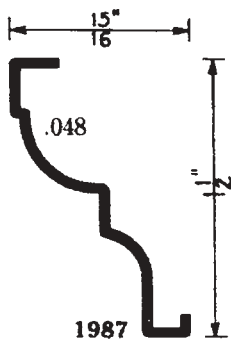
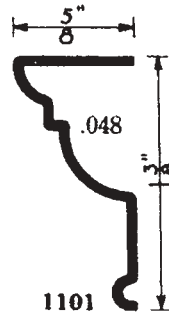
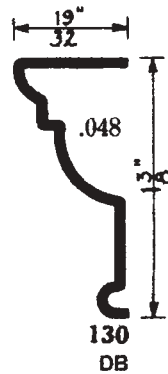
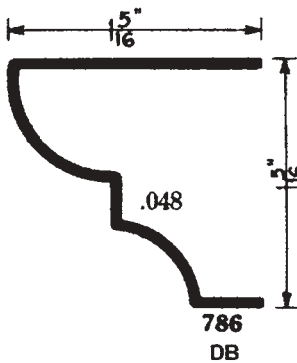
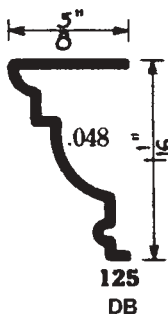
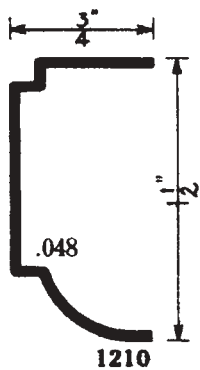
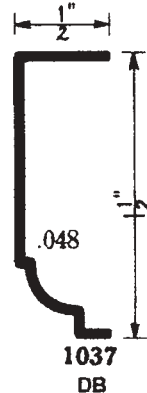
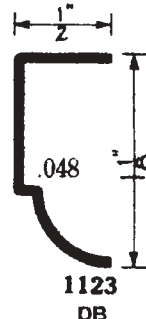
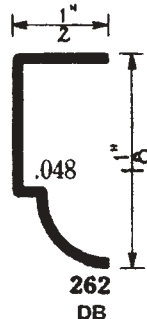
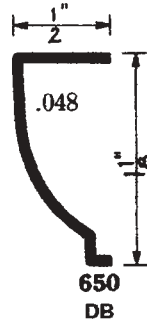
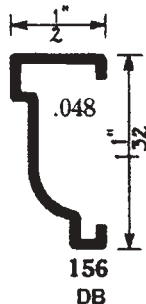
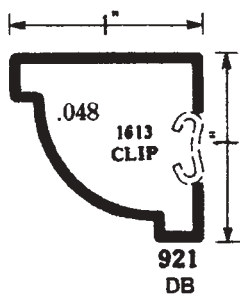
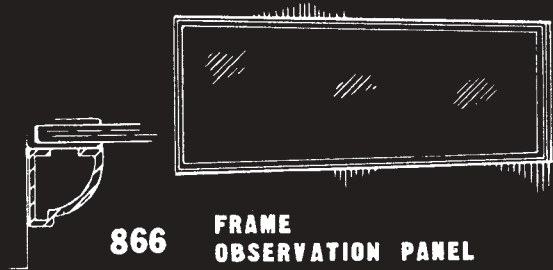
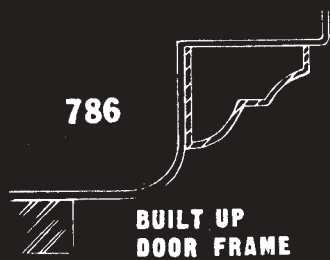
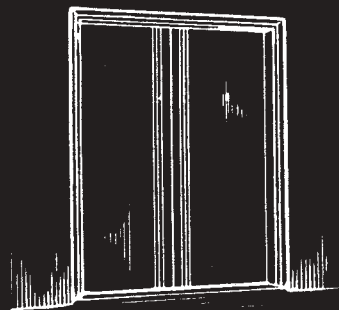

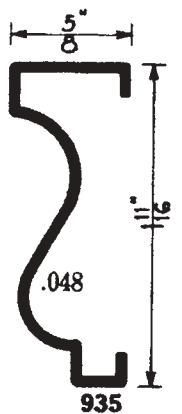
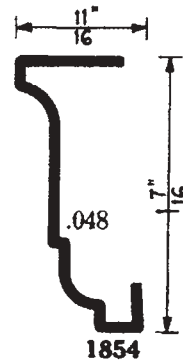
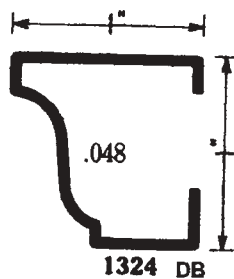
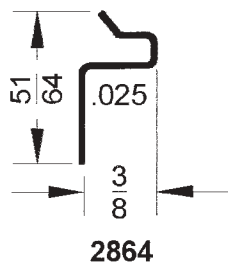
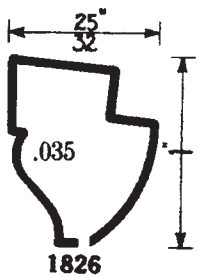
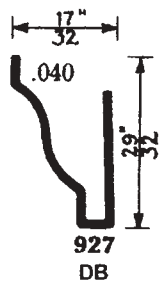
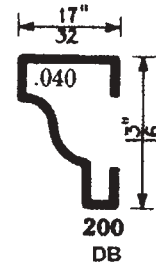
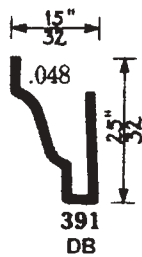
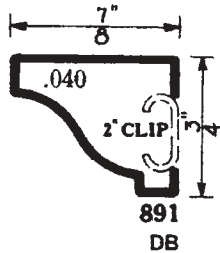
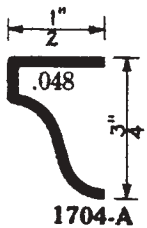
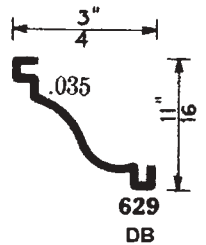
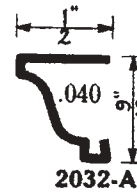
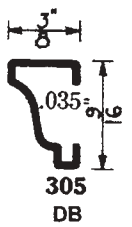
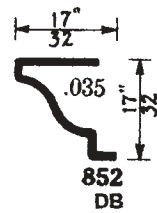
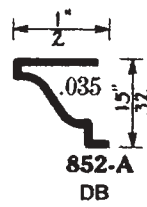
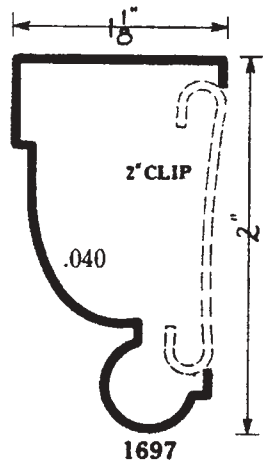
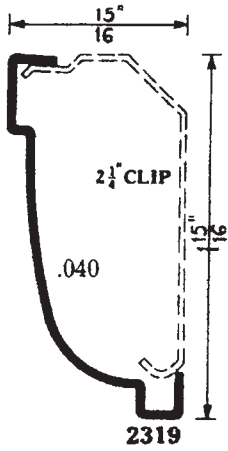
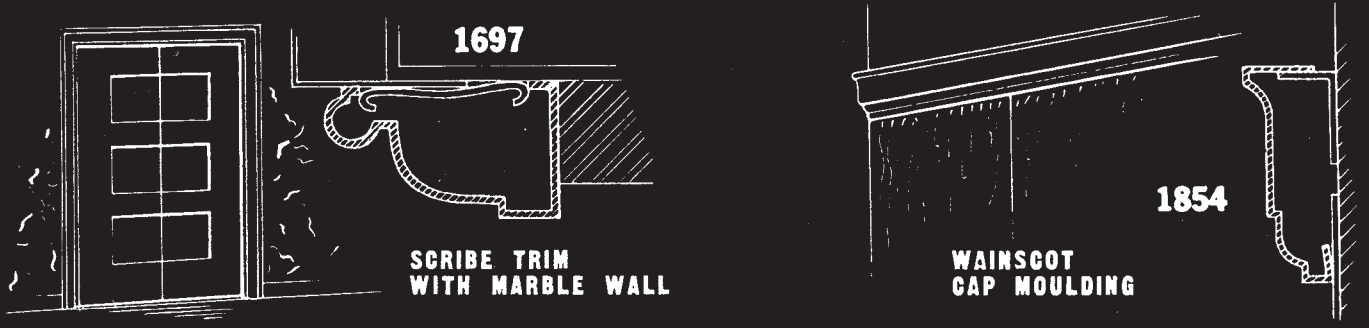

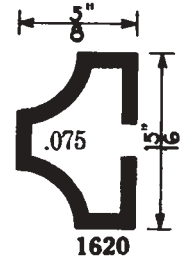
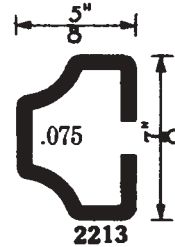
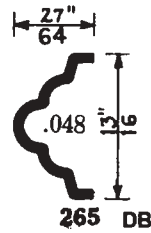
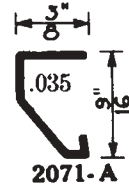
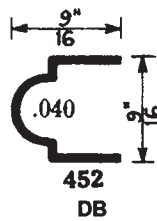
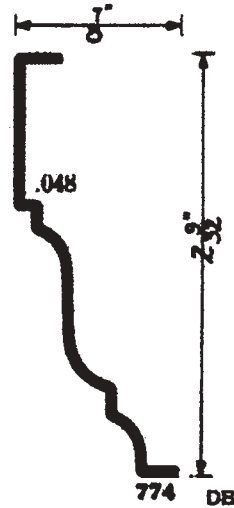
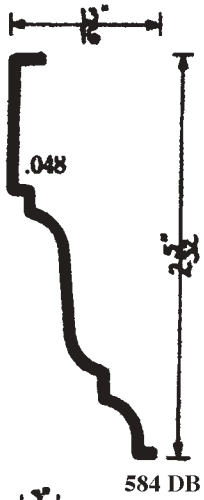
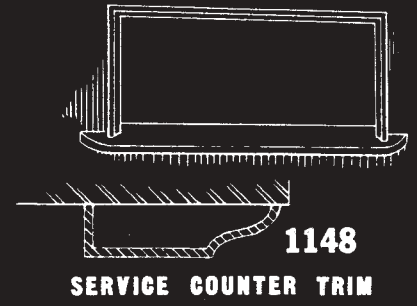
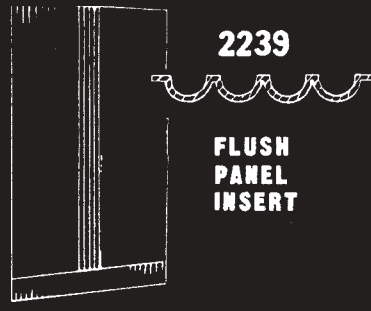

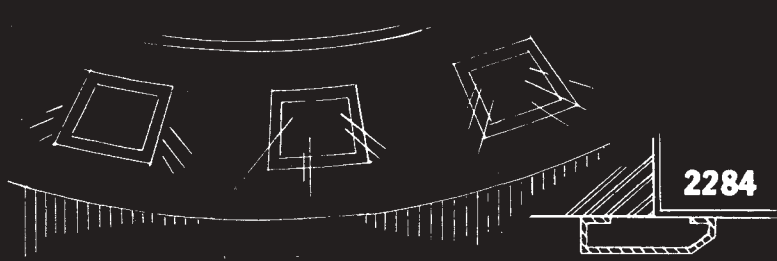

FRAMES — RECESSED CEILING LIGHTS

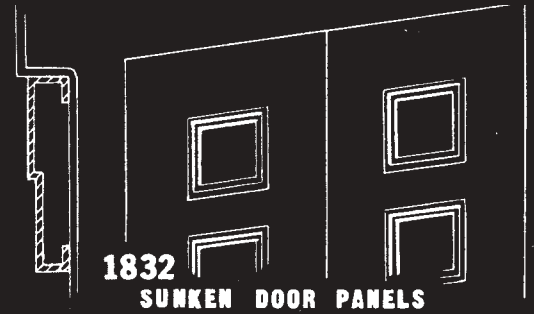

1832
SUNKEN DOOR PANELS

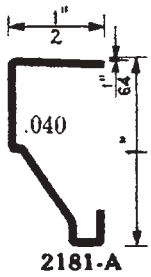

2181-A

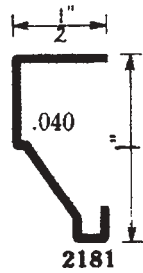

2181

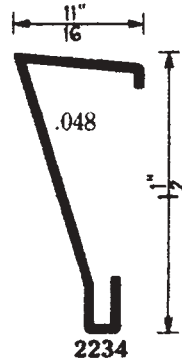

2234



1832

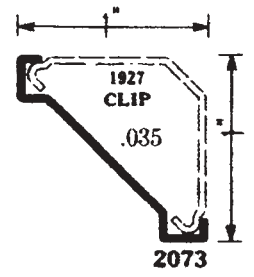

2073

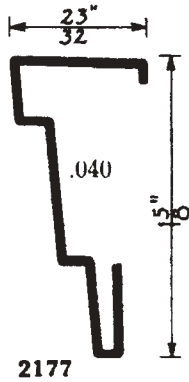

2177

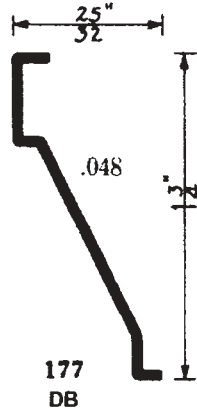

177
DB

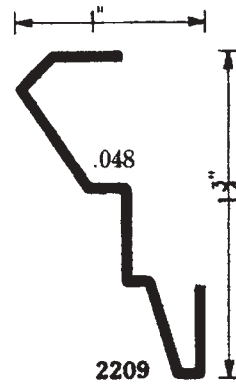

2209

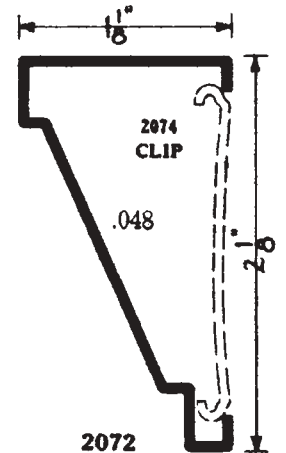

2072

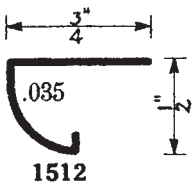

1512

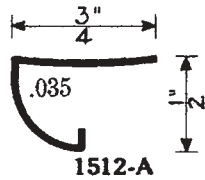

1512-A

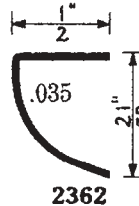

2362

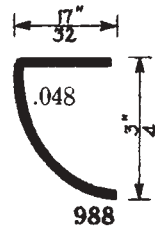

988

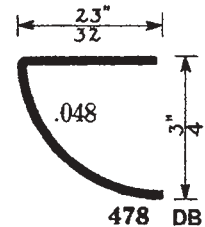

478
DB

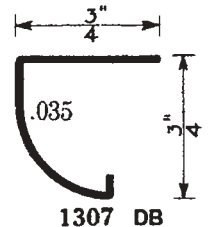

1307
DB

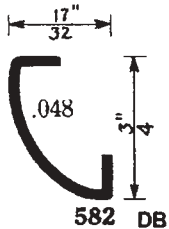

582
DB

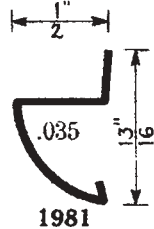

1981

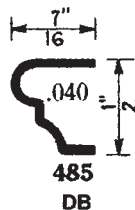

485
DB

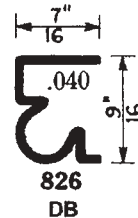

826
DB

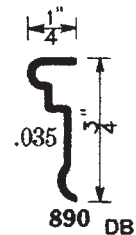

890
DB

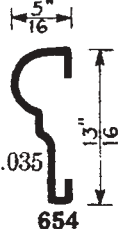

654

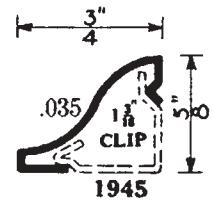
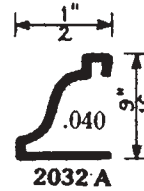
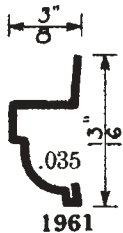
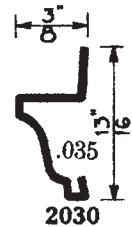
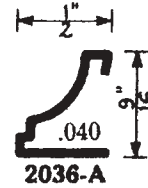
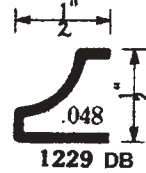
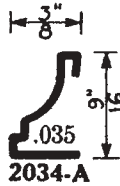
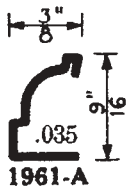
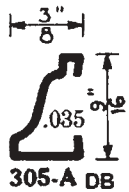
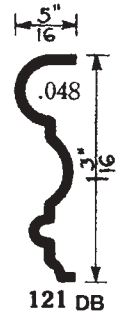
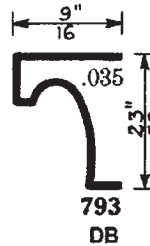
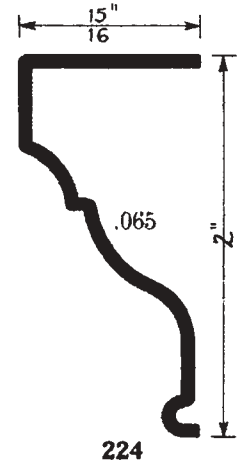
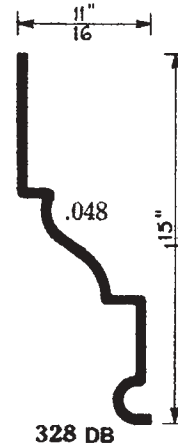
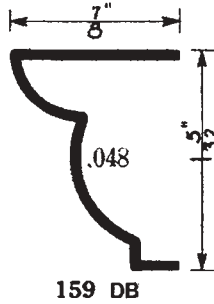
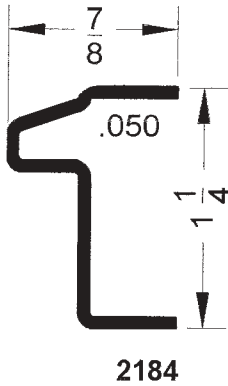
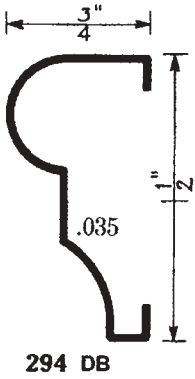
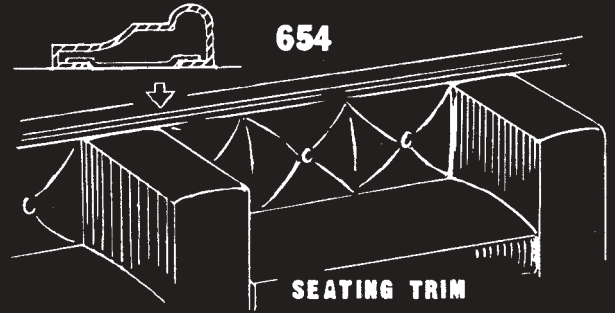
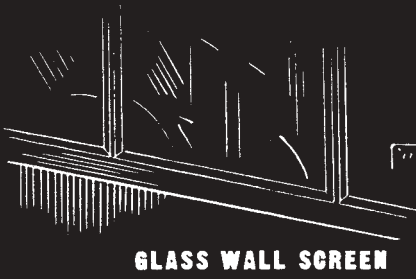

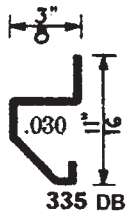
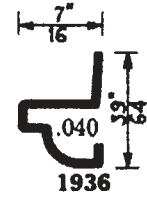
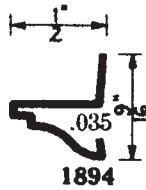
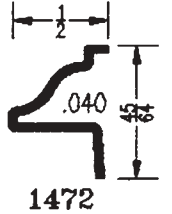
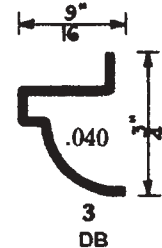
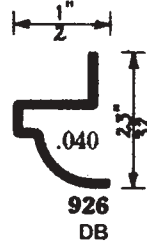
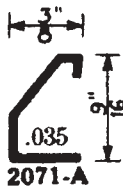
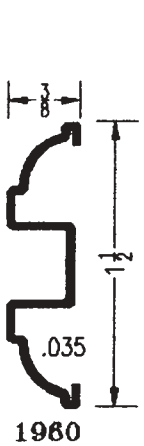
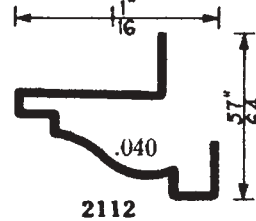
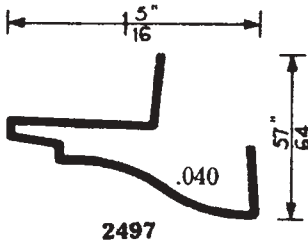
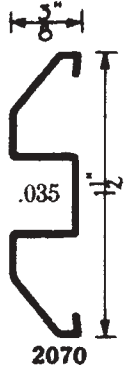
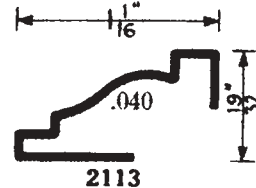
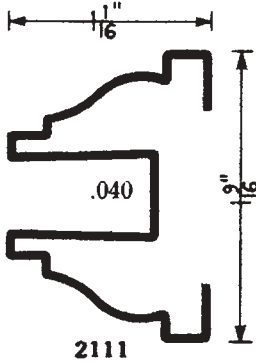
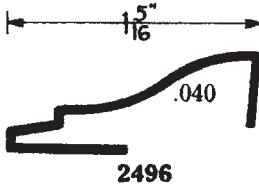
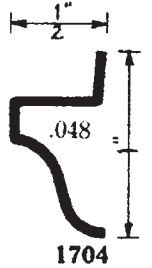
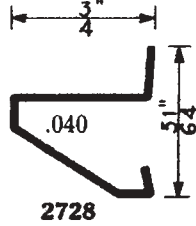
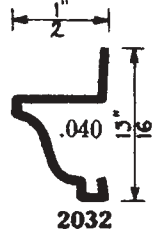
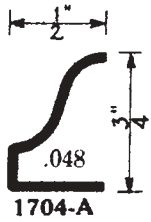
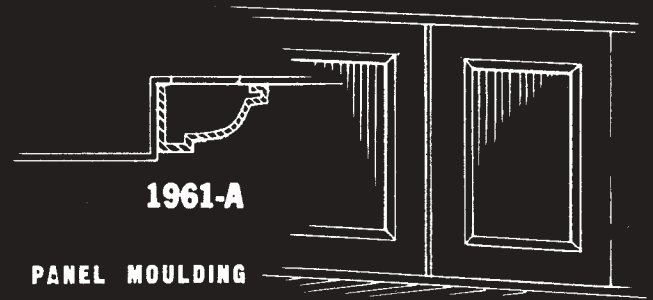
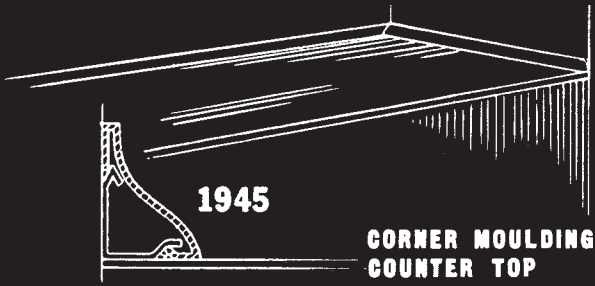

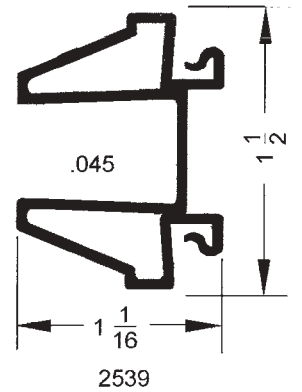
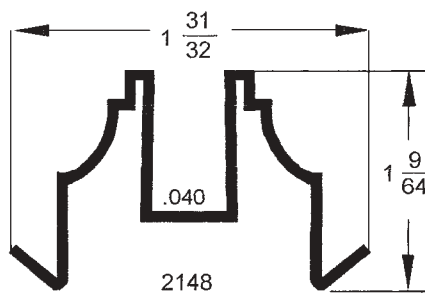
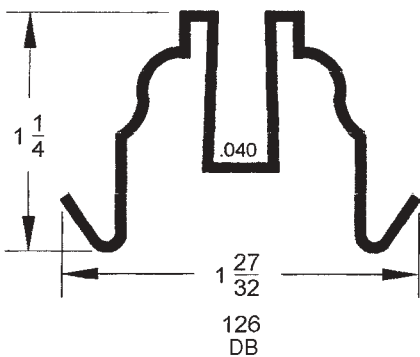
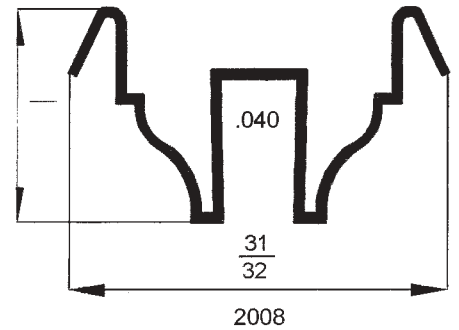
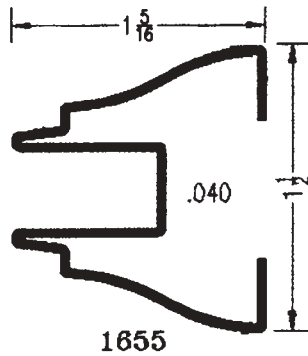
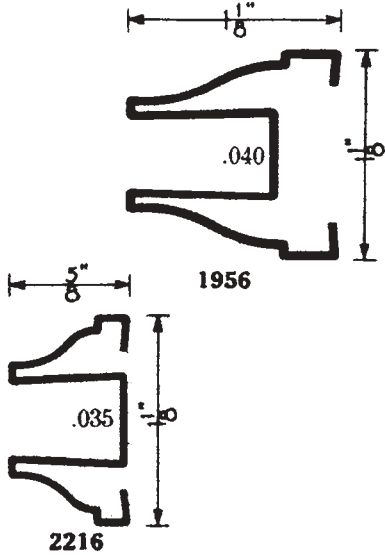
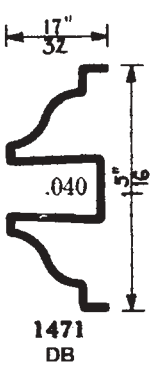
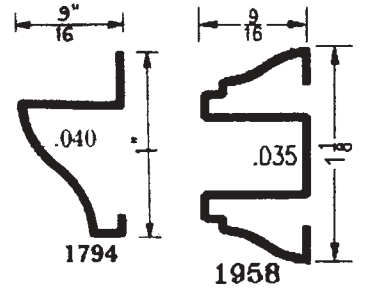
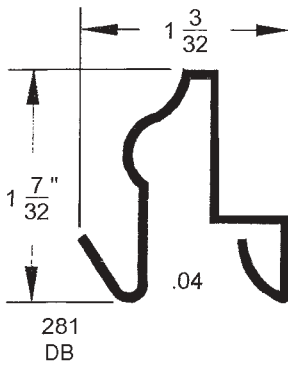
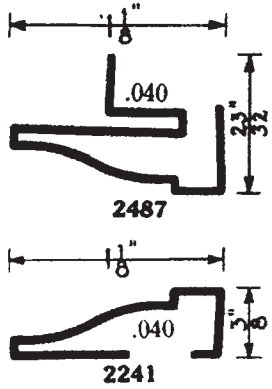
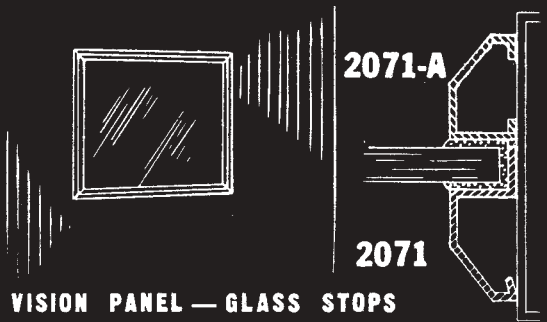
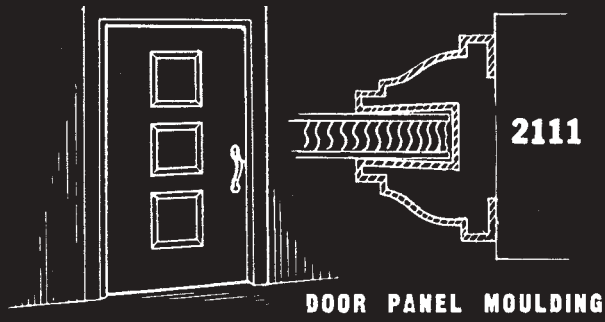

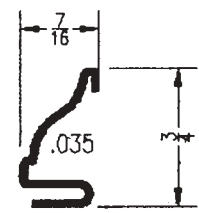
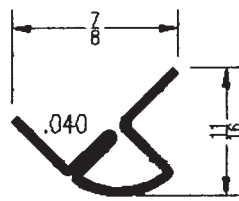
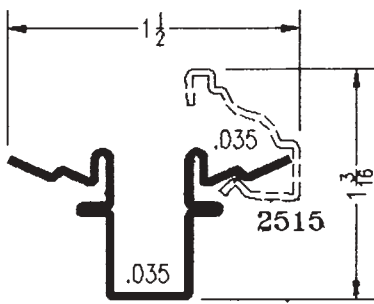
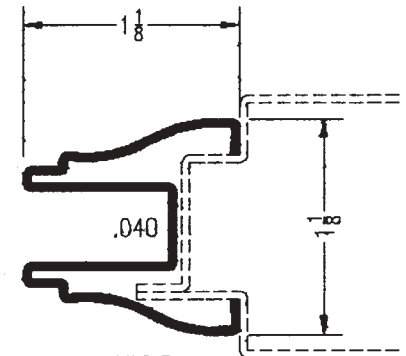
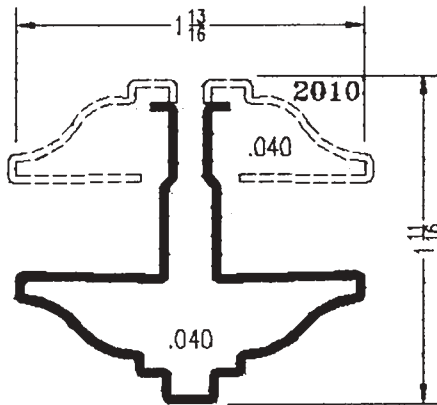
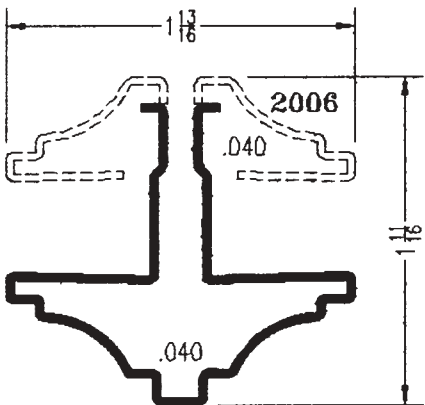
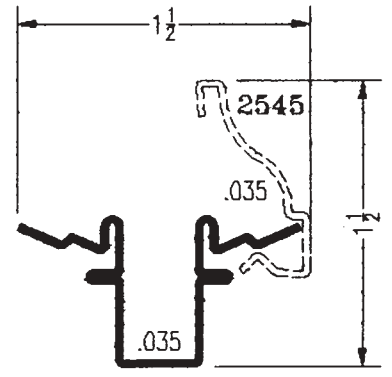
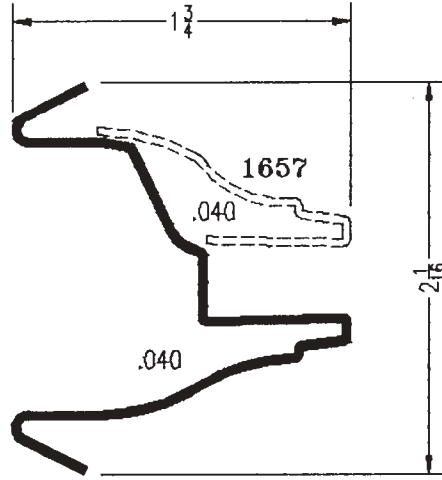
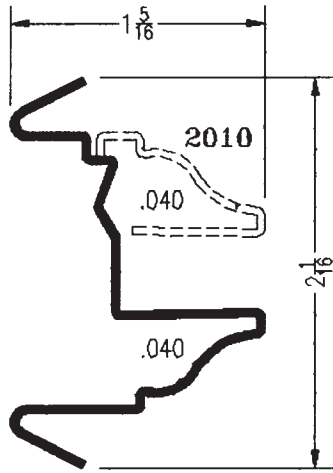
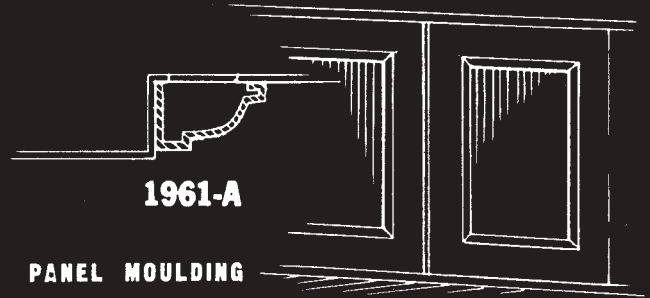
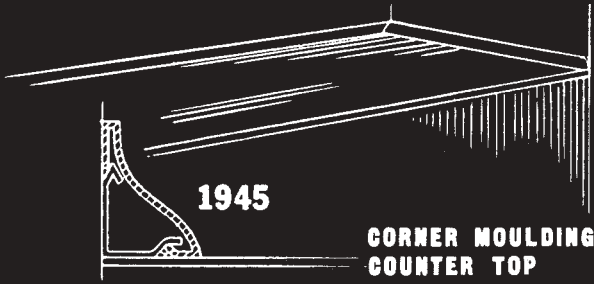

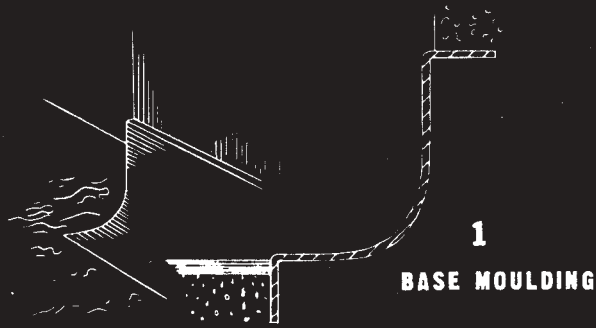

2214

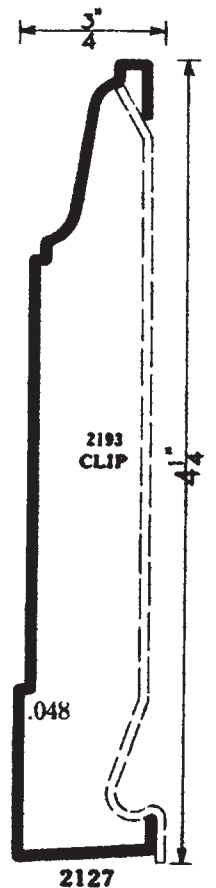
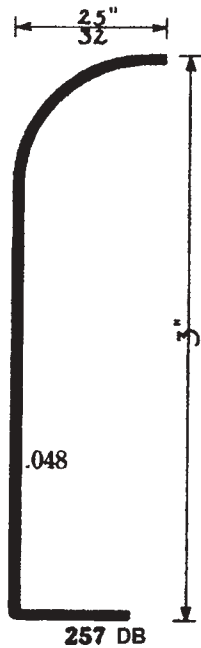
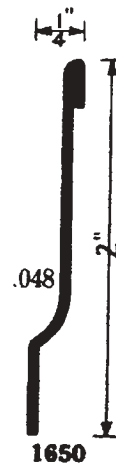
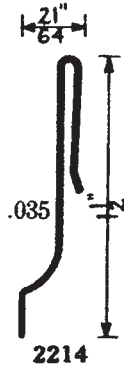
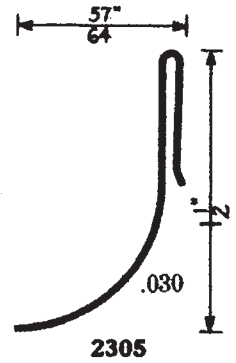
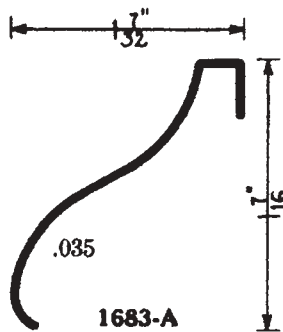
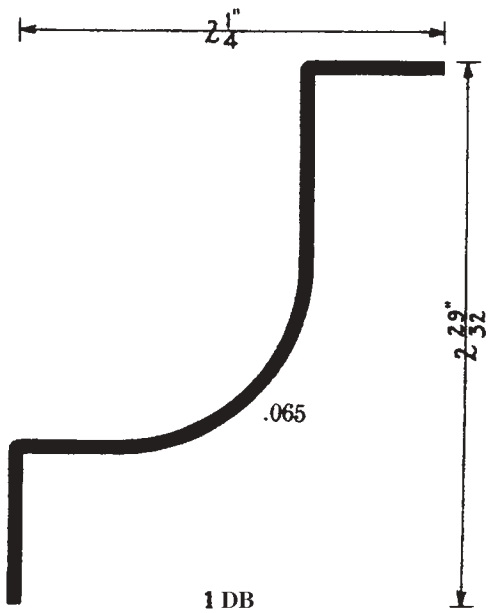

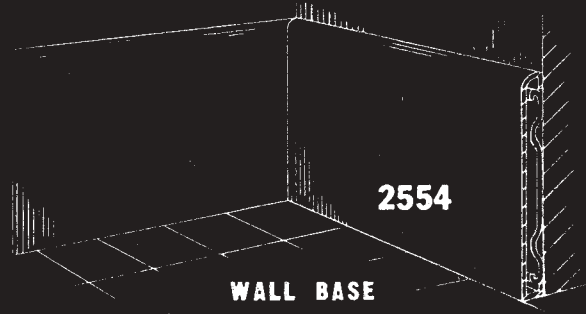

AS A
CORNICE
2186

