

CLIPS FOR BEAD TRIM

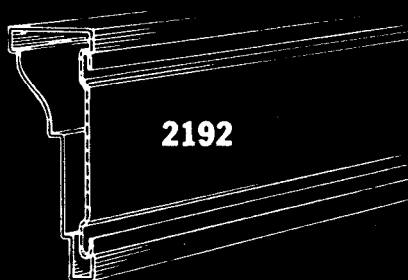

CASING CLIP

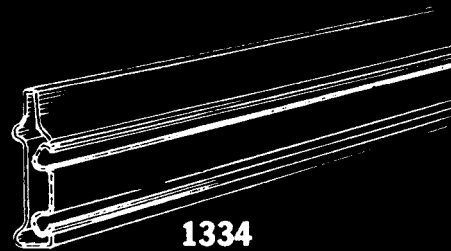

PICTURE MOULDING CLIP

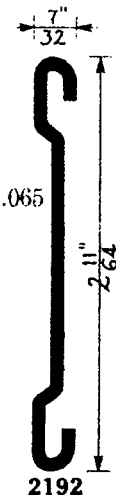
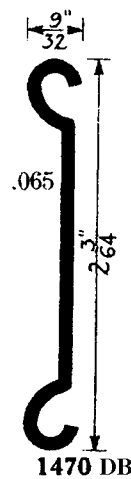
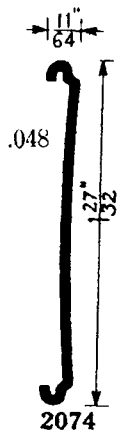
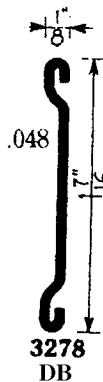
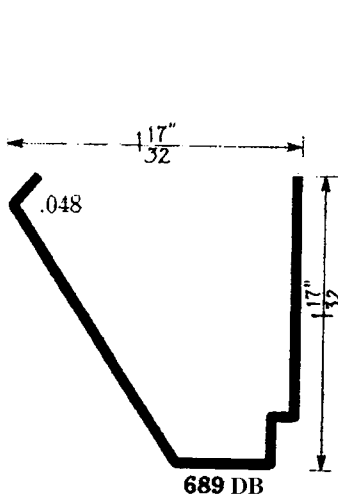
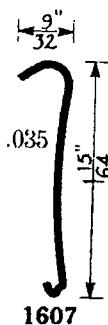
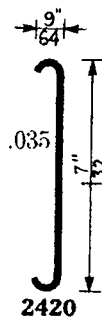
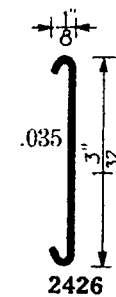
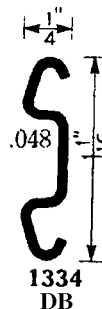
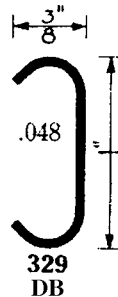
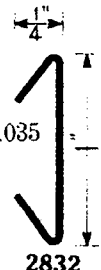
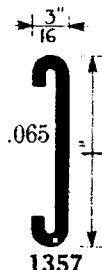
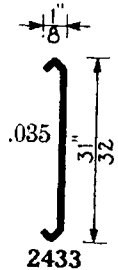
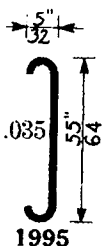
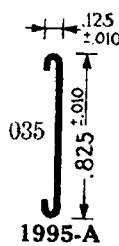
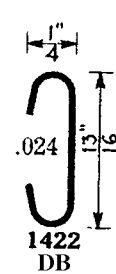
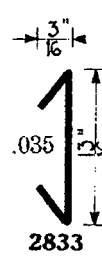
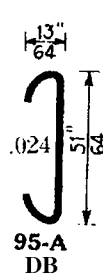
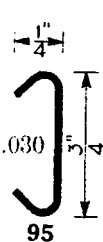
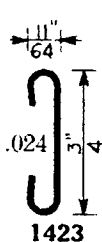
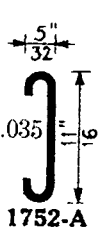
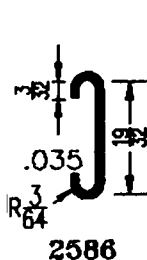
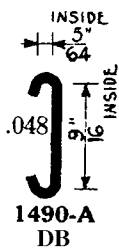
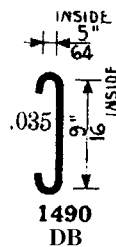
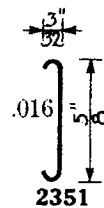
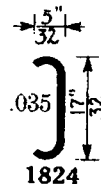
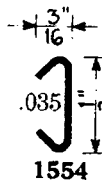
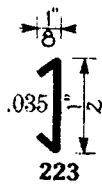
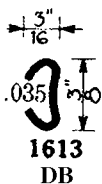
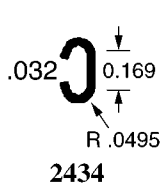

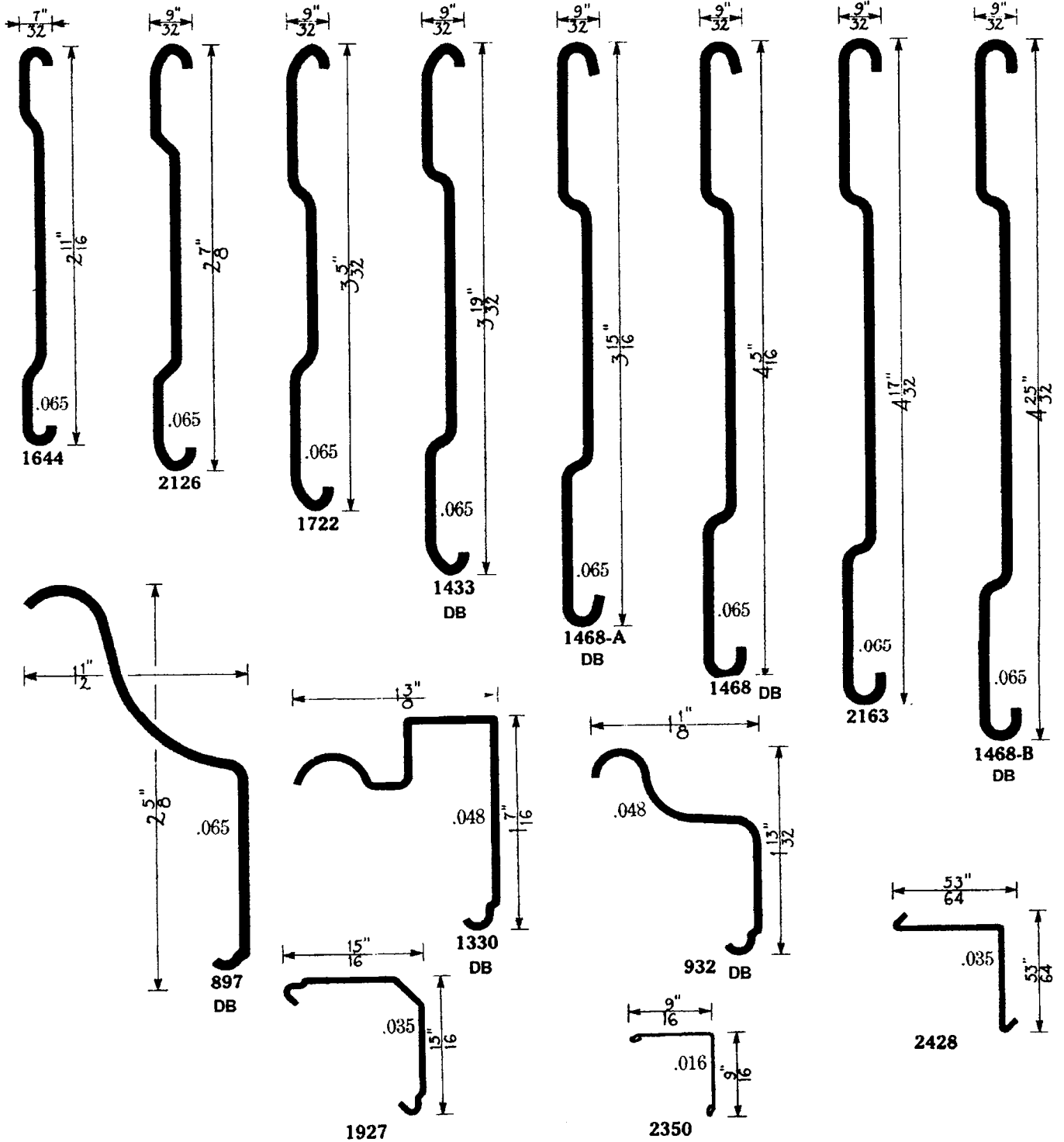
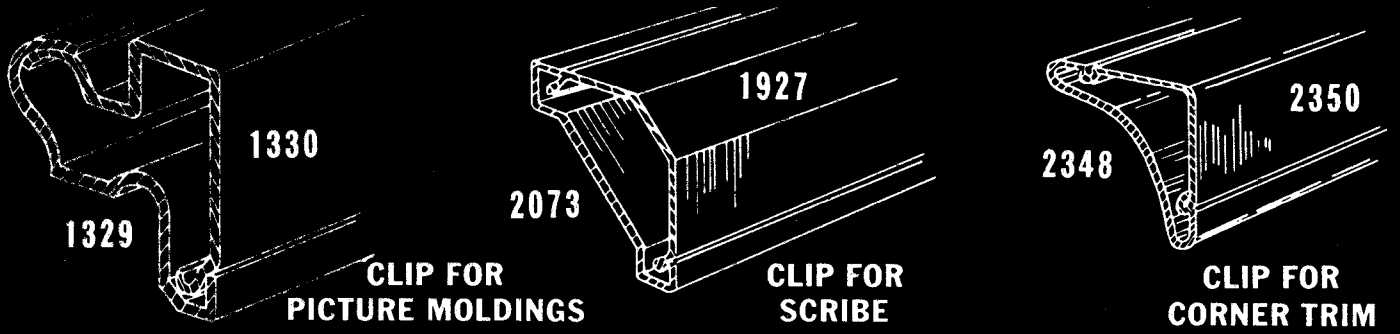



2448

EXPANSION JOINT

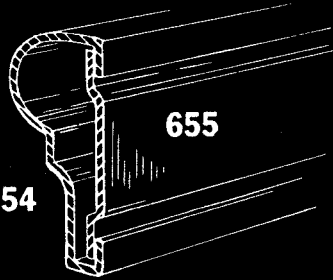

654

655

CLIP FOR BEAD TRIM

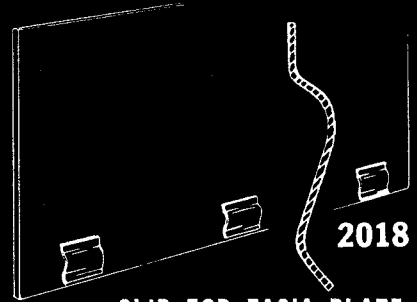

2018

CLIP FOR FACIA PLATE

