

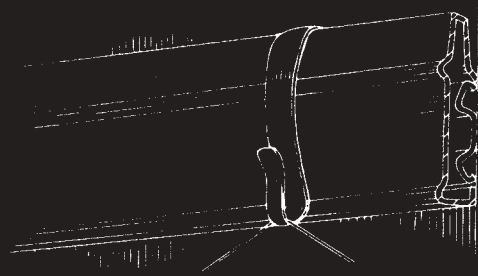

SECTION FOUR

- **PICTURE MOULDINGS**
- **WIRE MOULDINGS**
- **CORNICES**
- **HANDRAILS**
- **CAP MOULDINGS**
- **CHAIR RAILS**

Examples of cornice combinations are illustrated on page 76.
Others can be created by using different tooling combinations.



1333

PICTURE
MOULDING

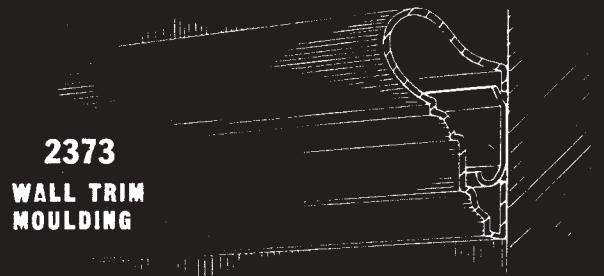

2373

WALL TRIM
MOULDING

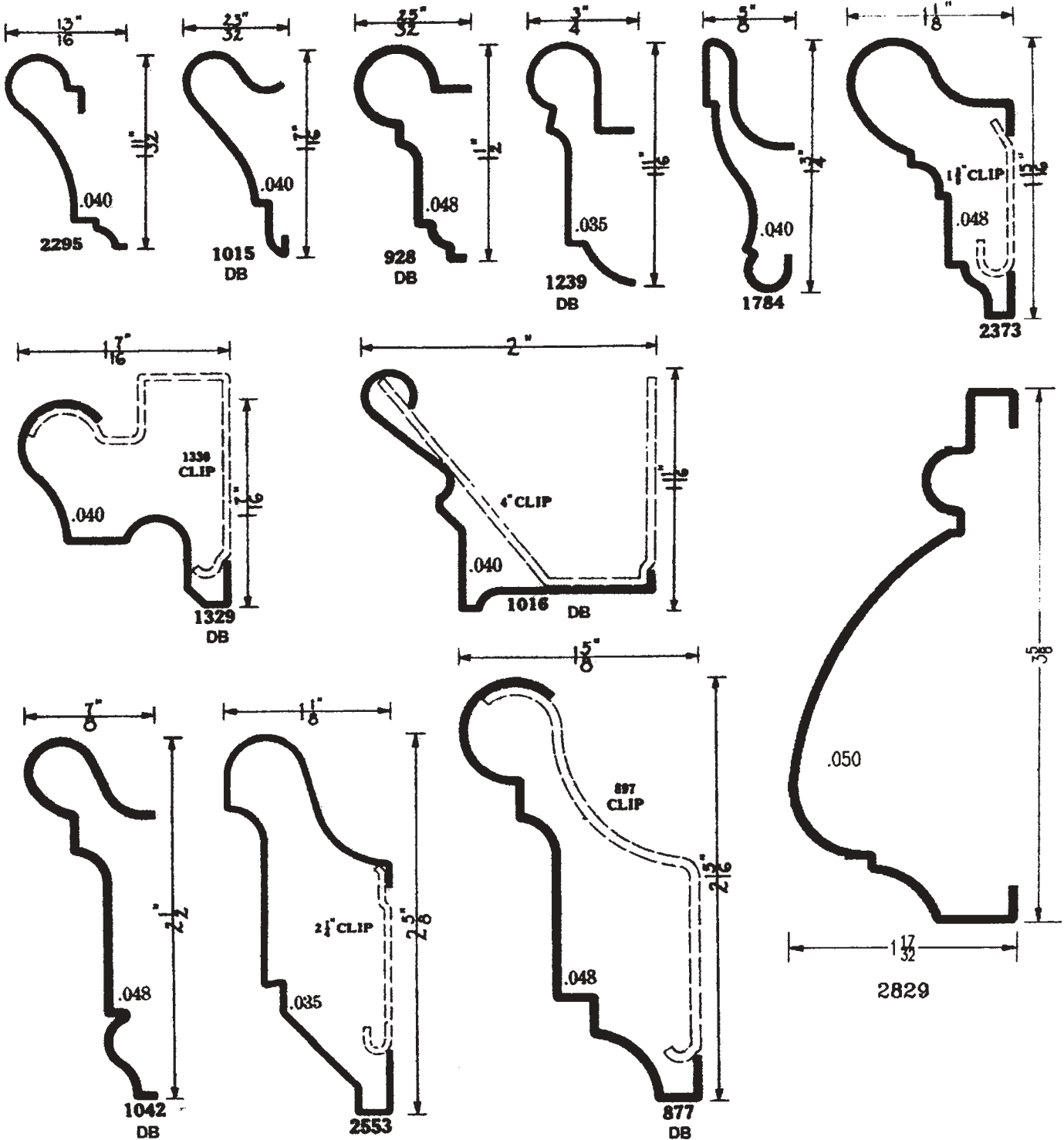

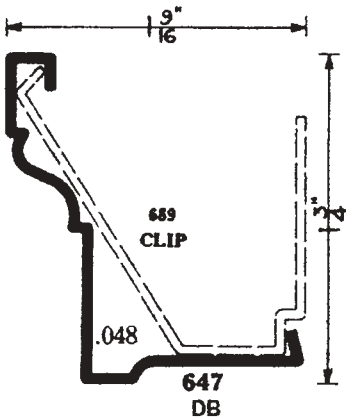
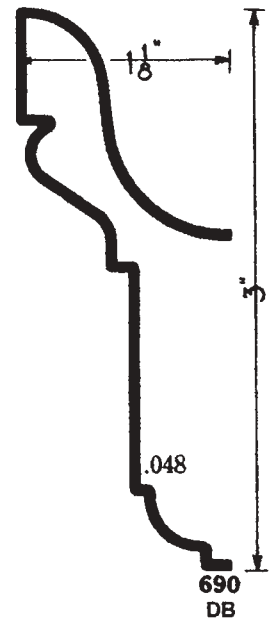
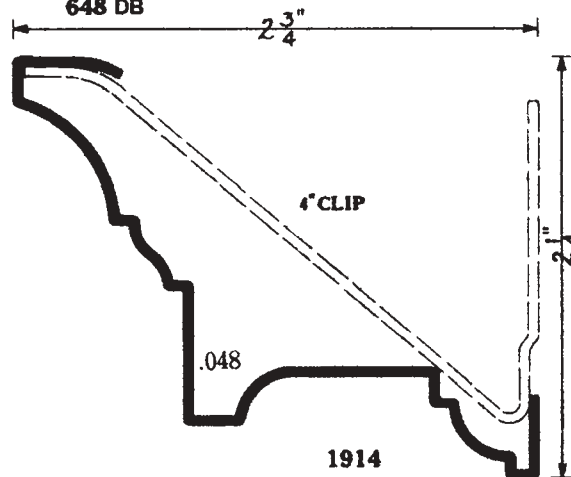
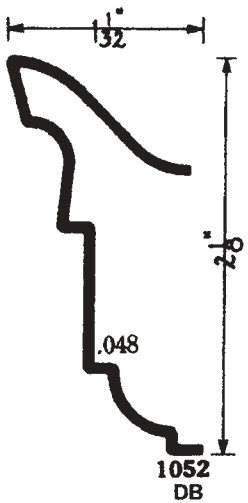
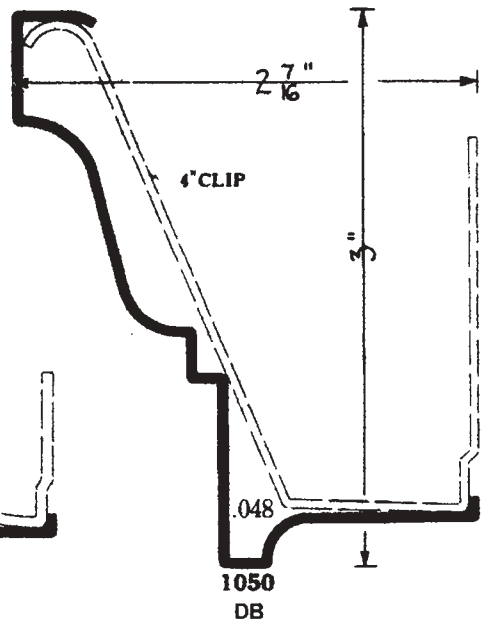
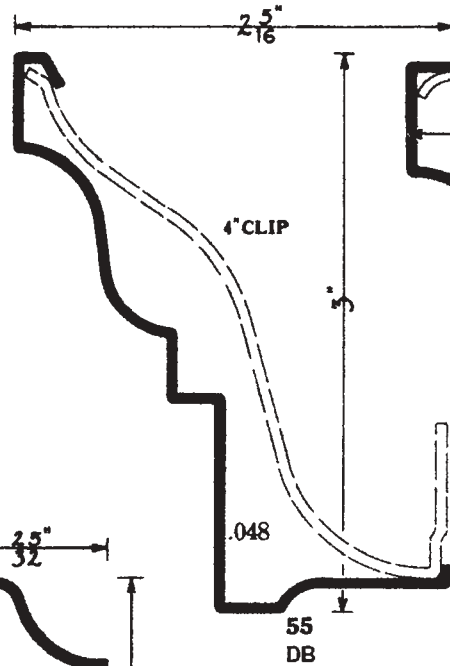
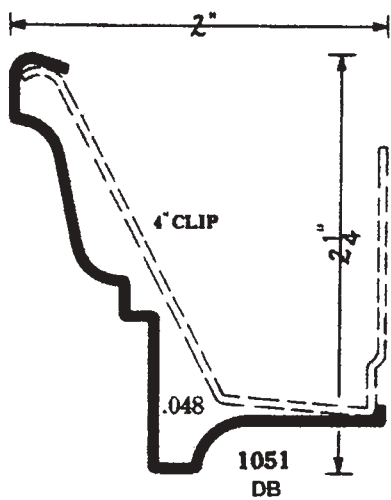
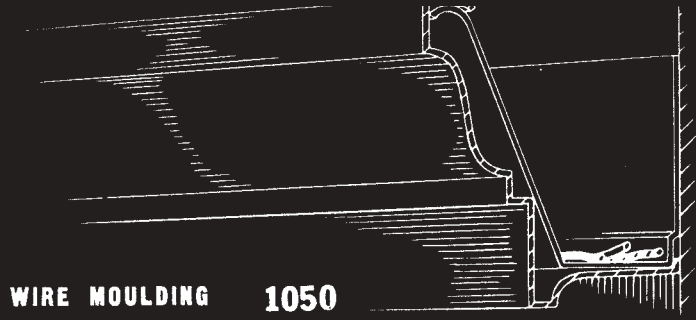
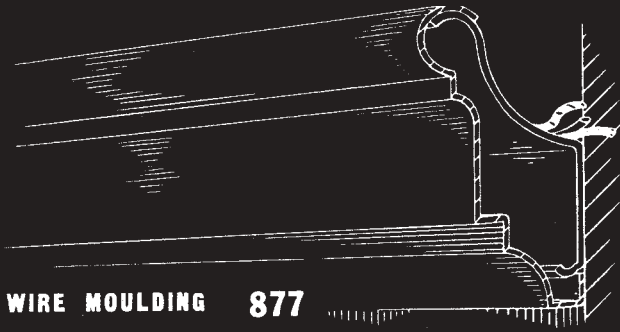

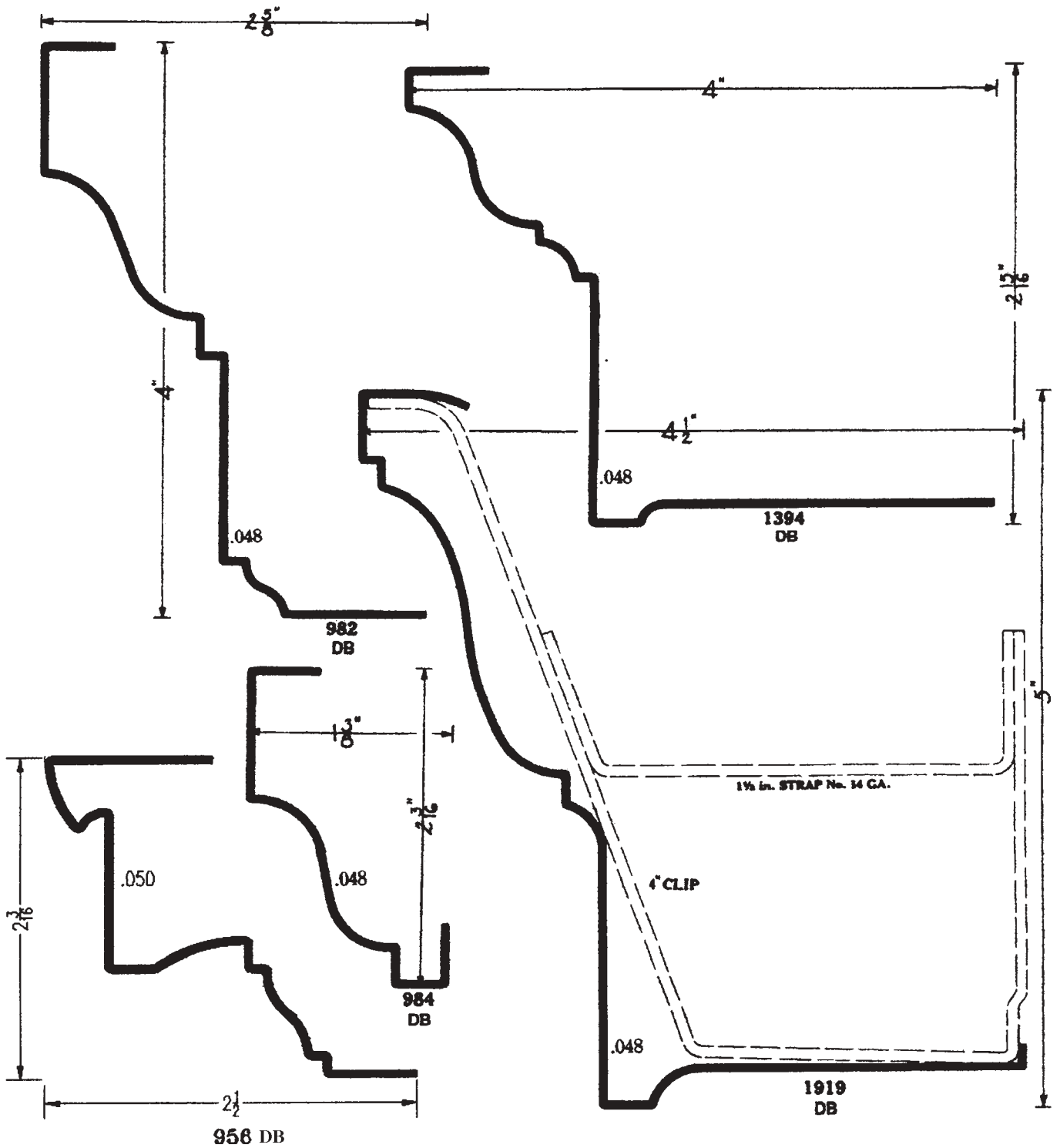
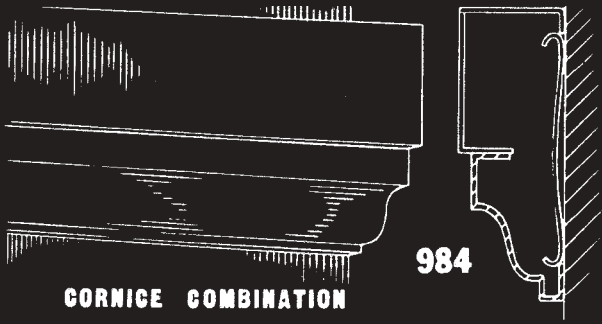

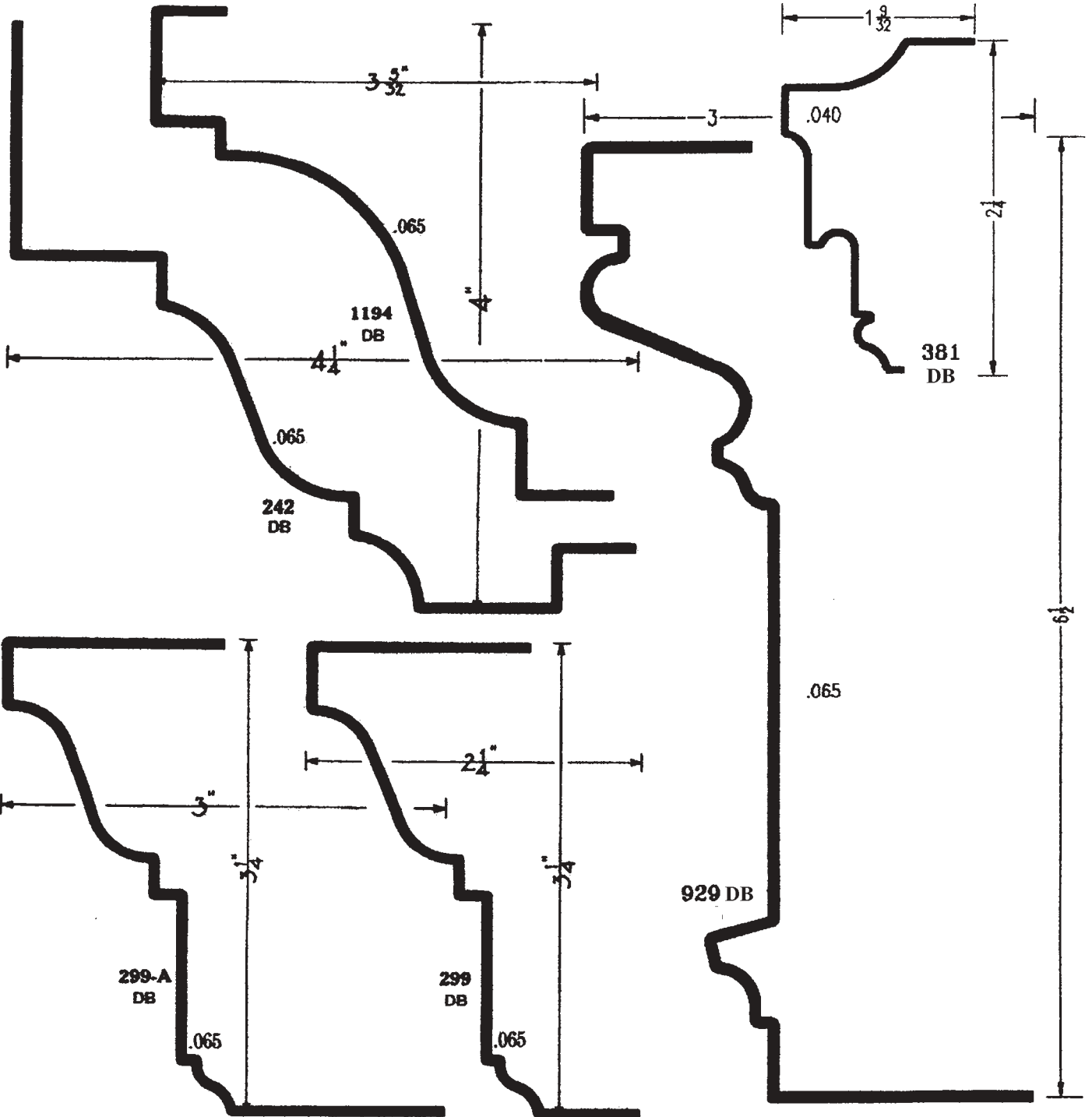
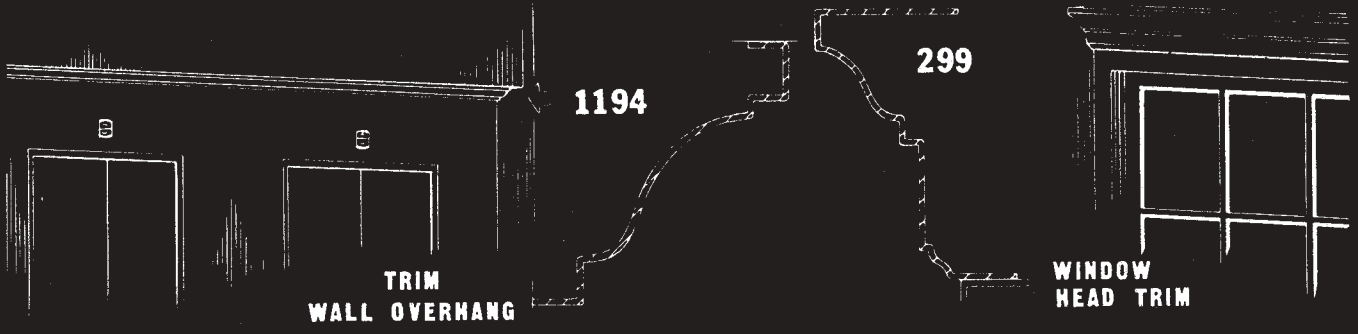

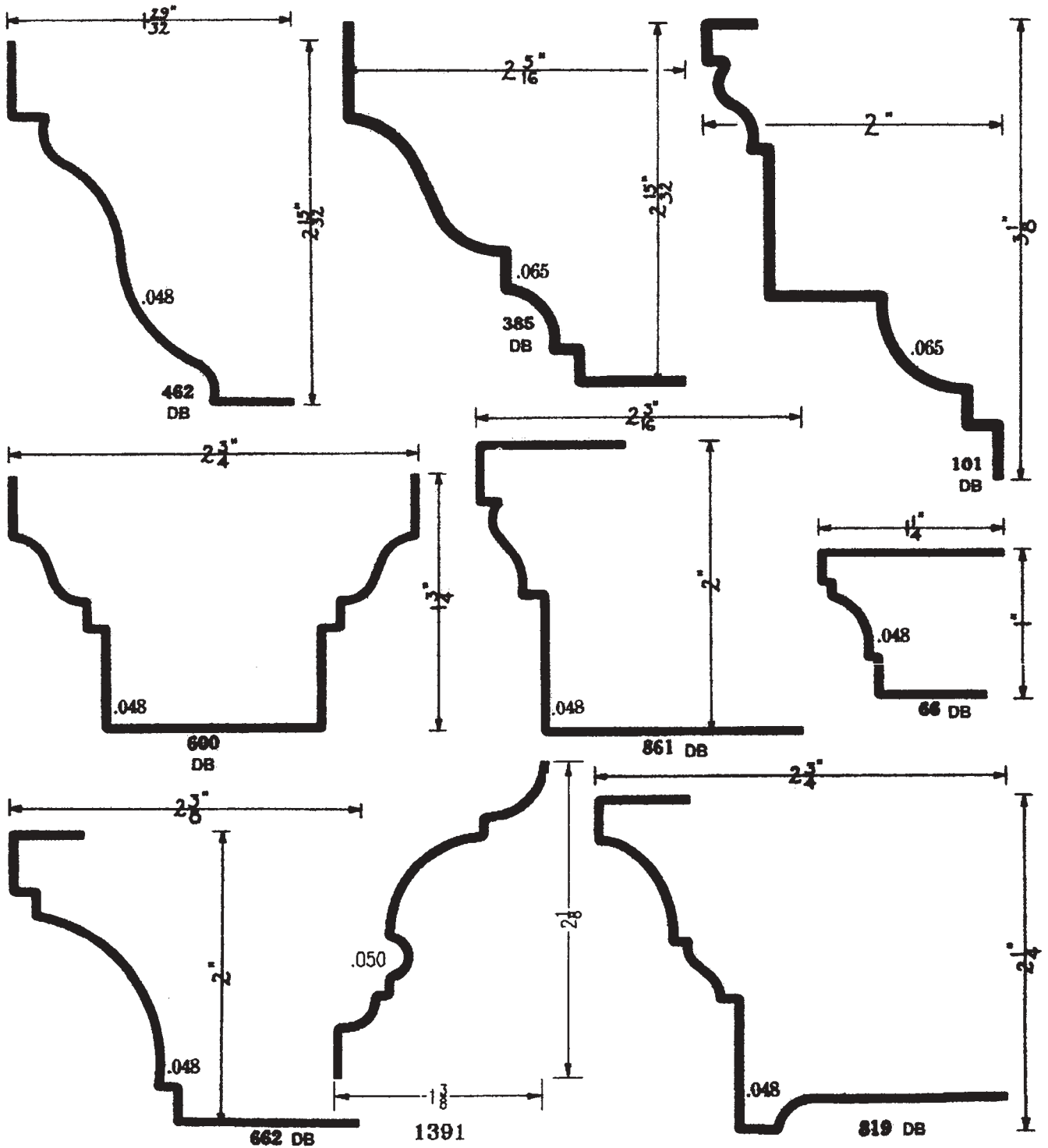
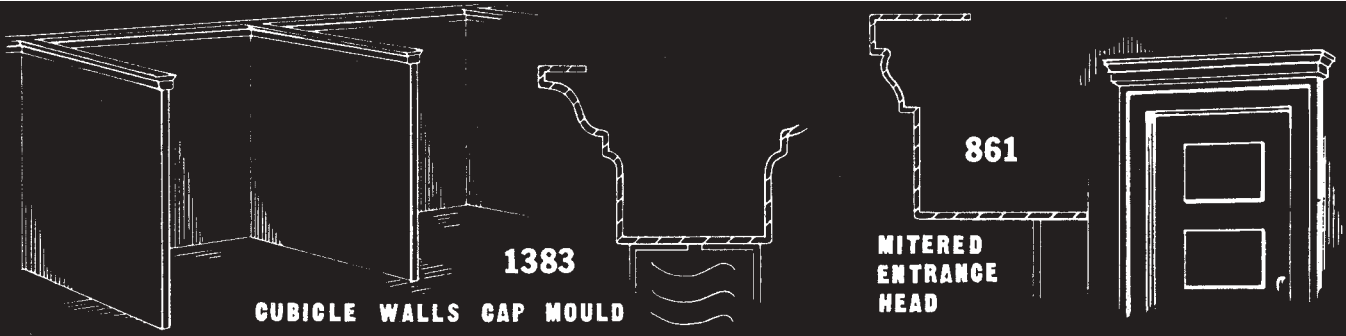

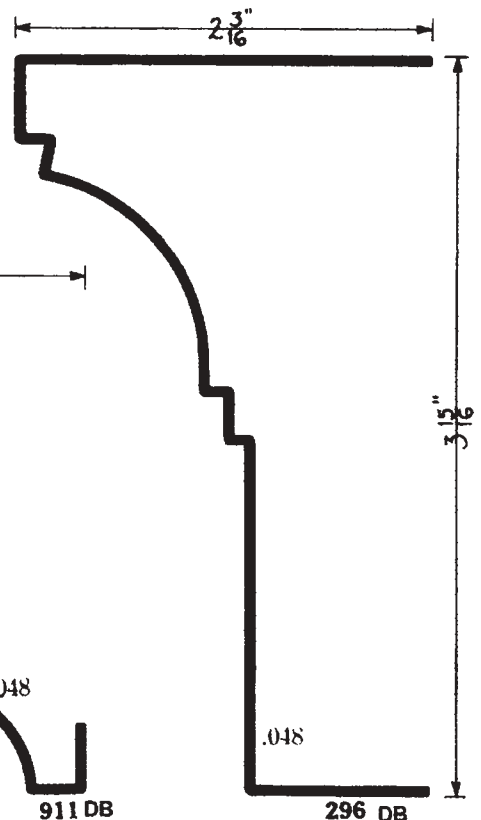
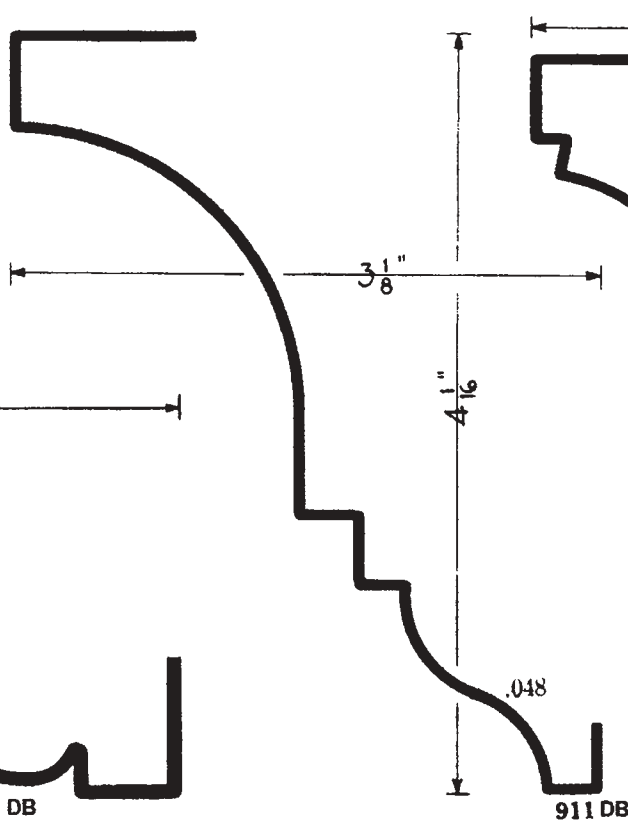
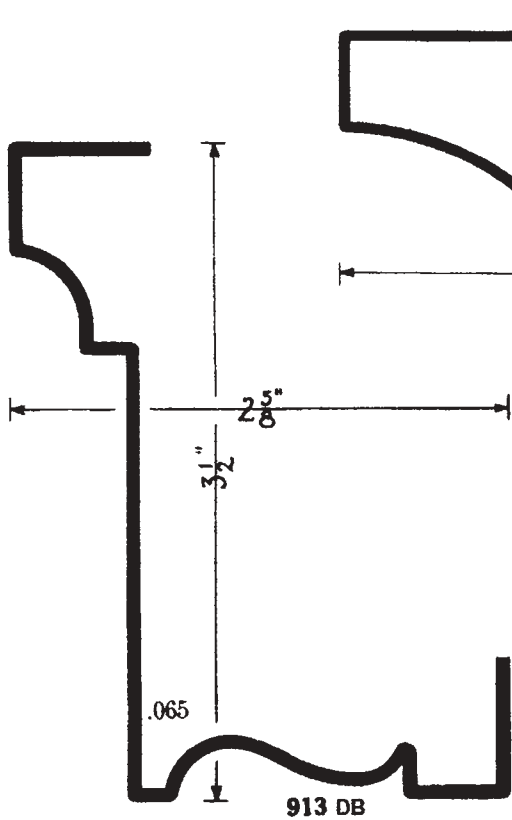
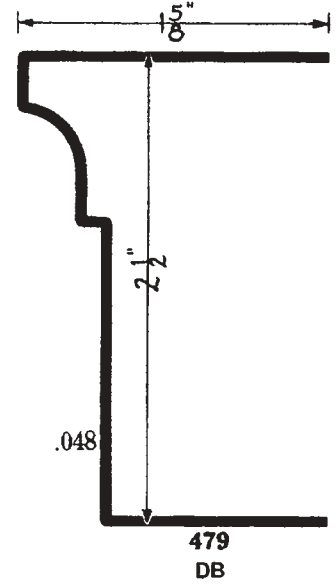
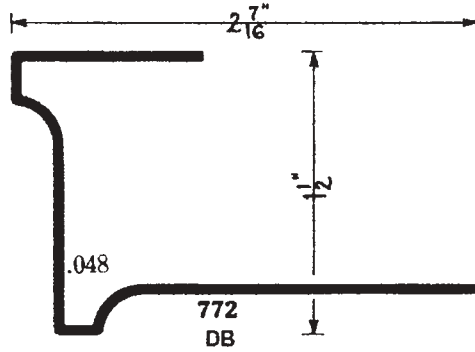
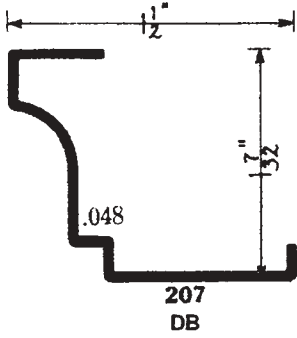

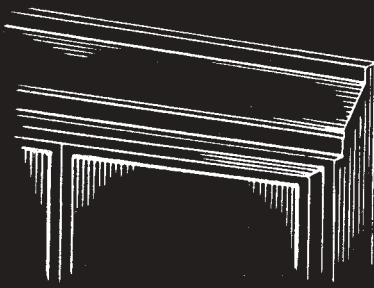

2253
RECESSED
HEAD BAND

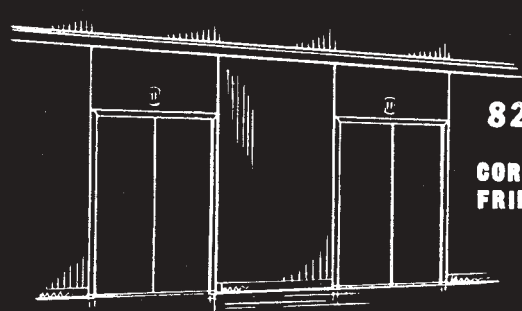

821
CORNICE
FRIEZE

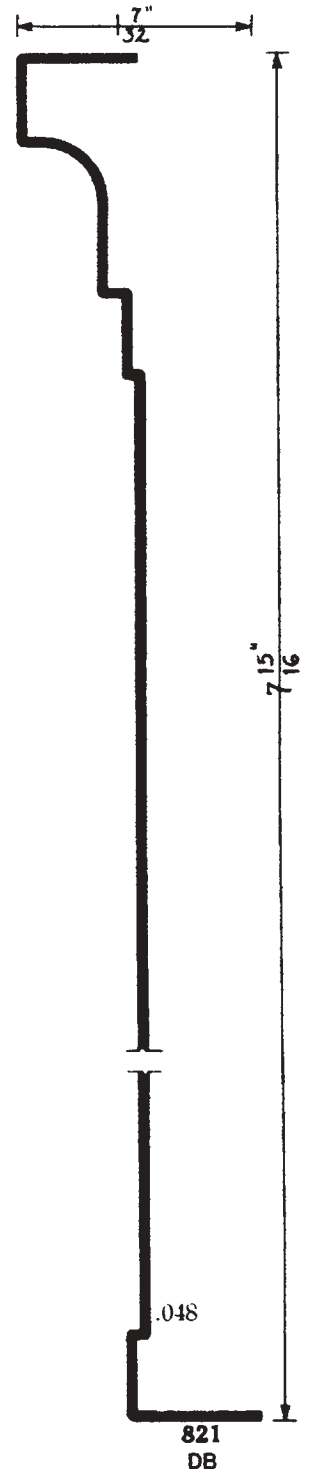
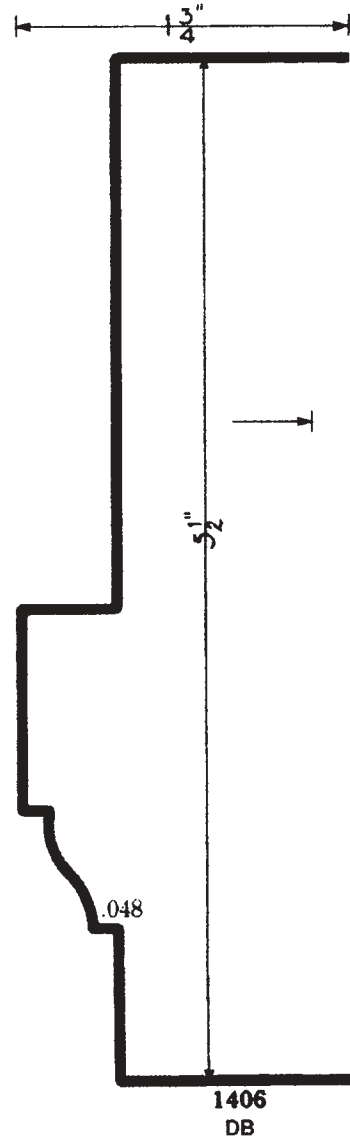
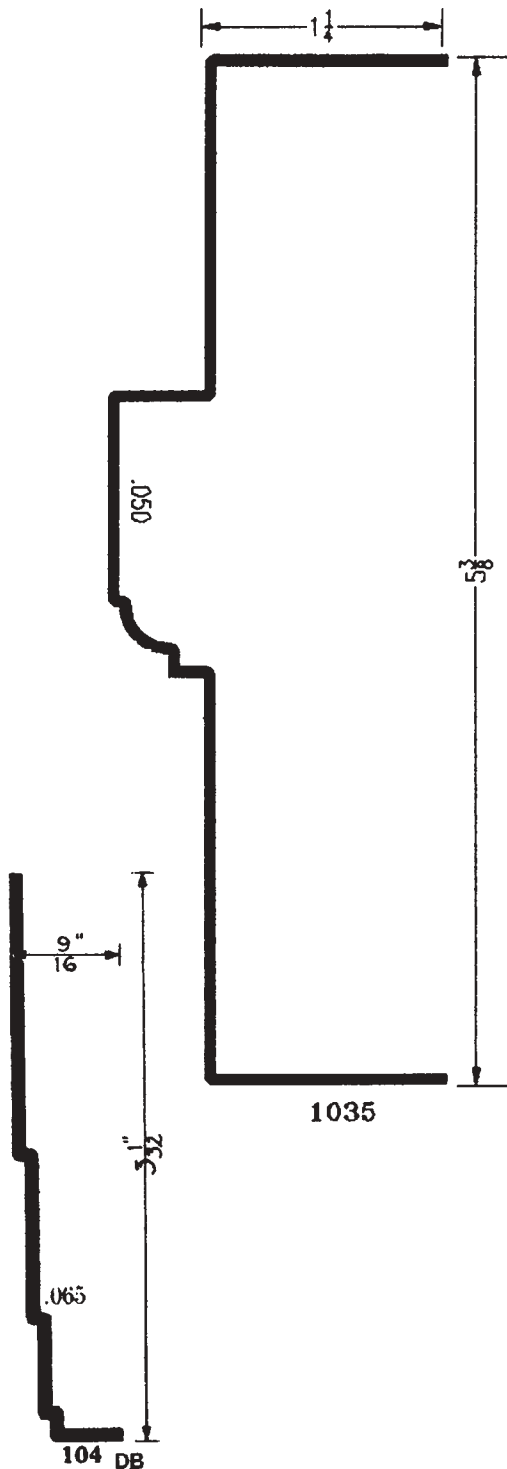

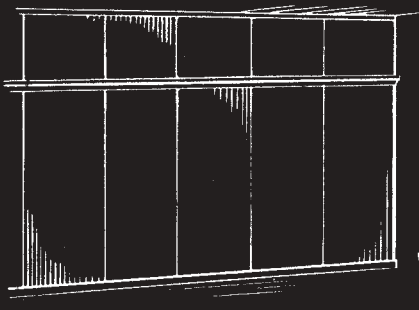

753

**PANEL
WALL
CORNICHE**

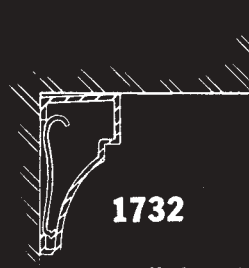

1732

TRIM FOR WALL OVERHANG

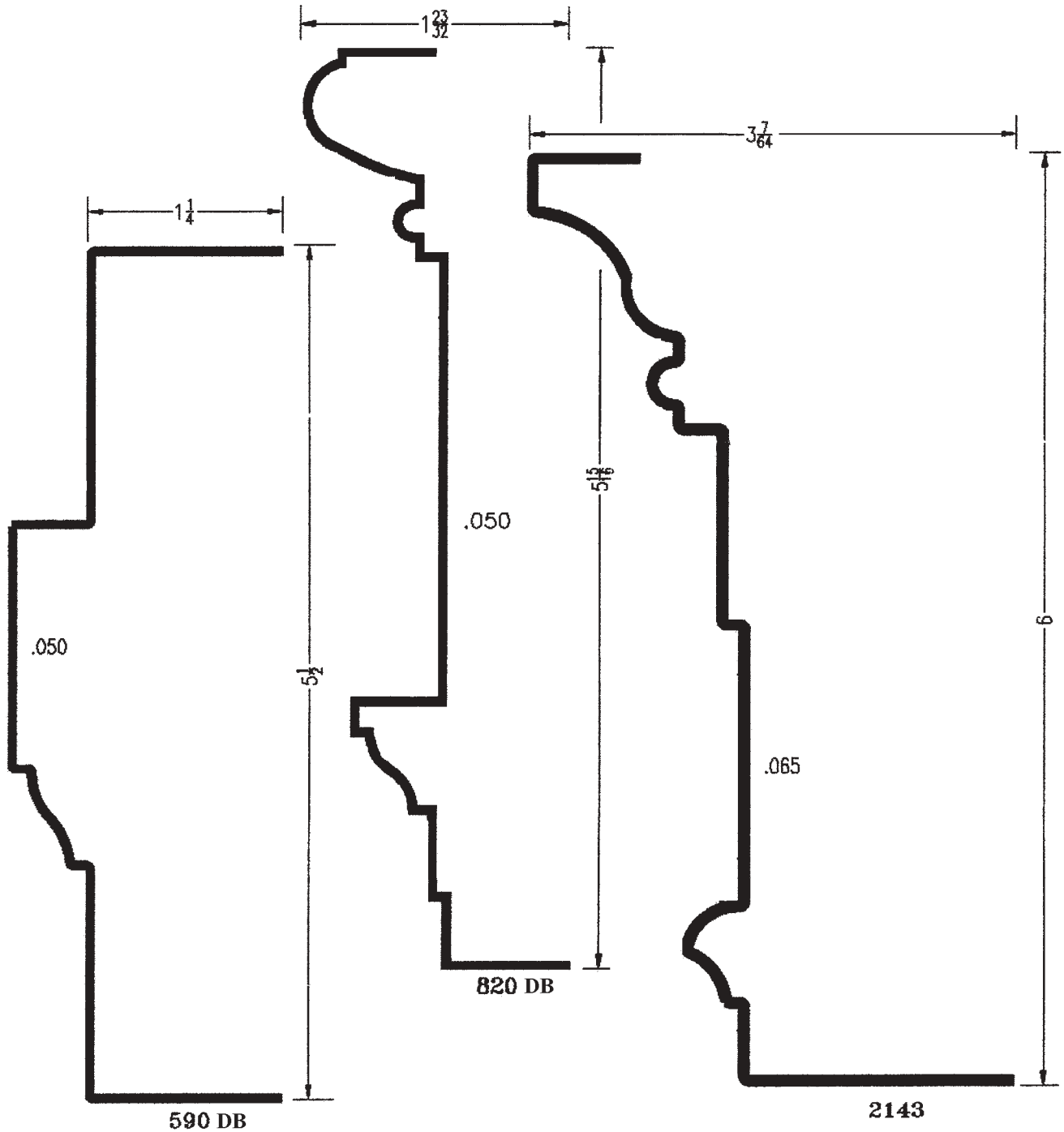

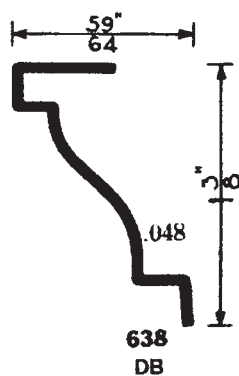
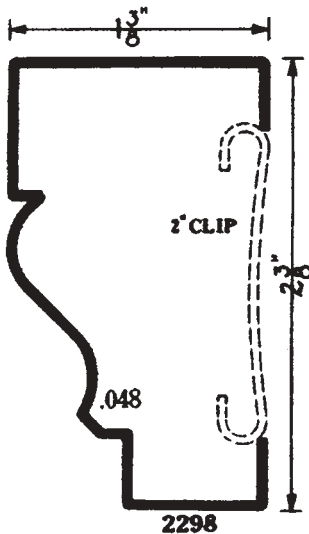
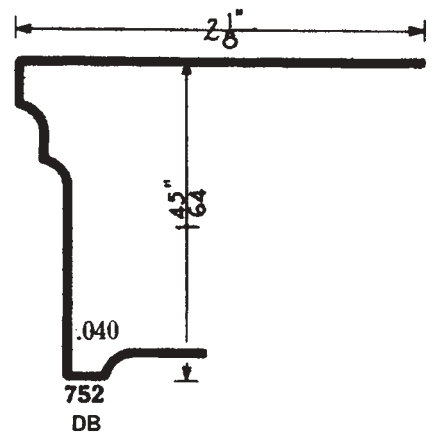
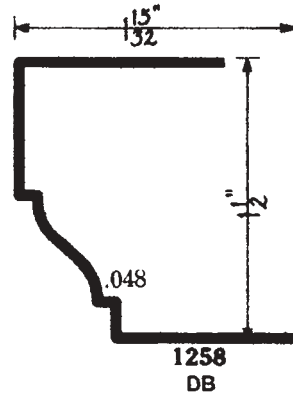
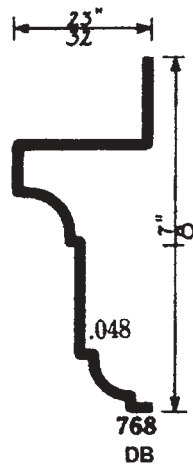
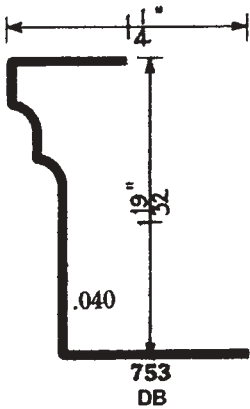
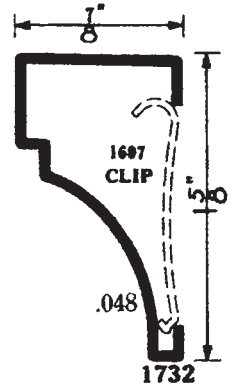
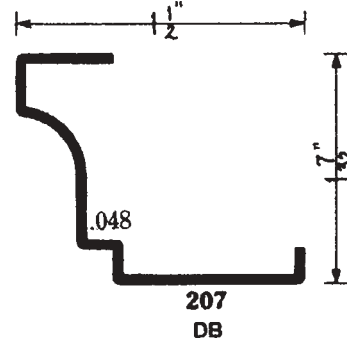
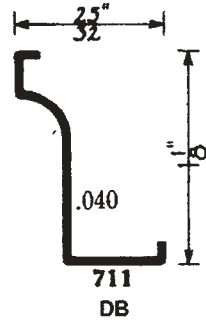
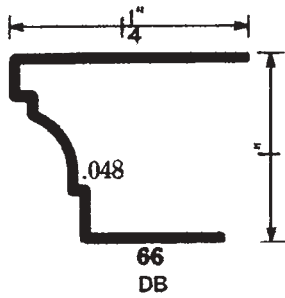
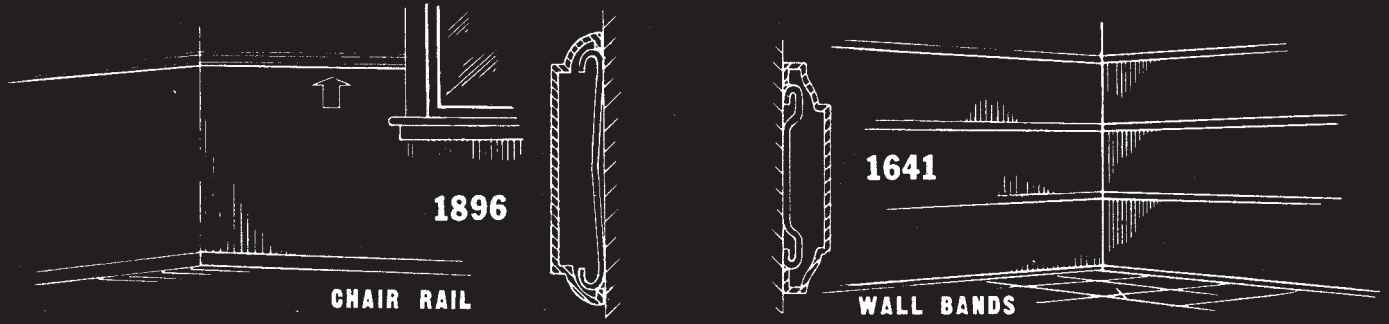



217
WINDOW
GUARD
RAIL

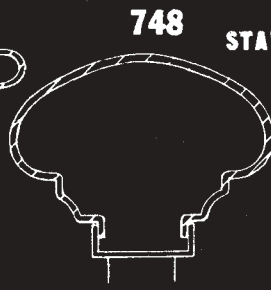

748 STAIR HAND RAIL

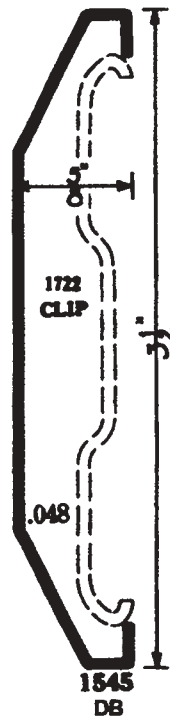
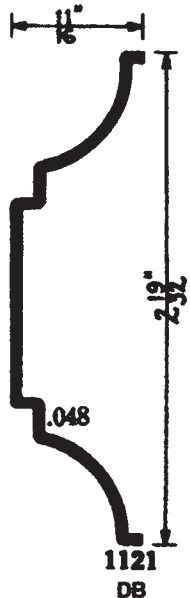
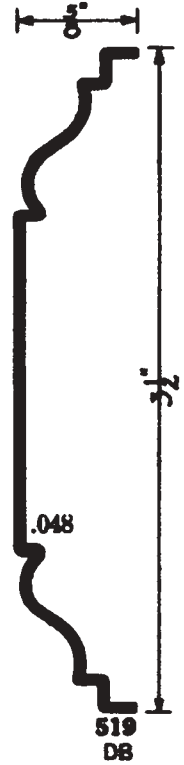
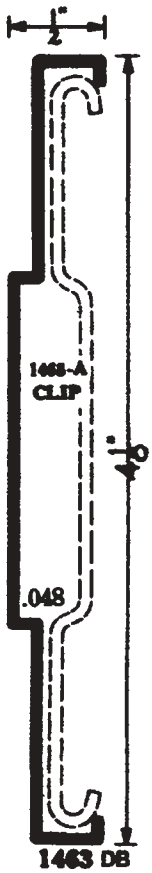



748 STAIR HAND RAIL

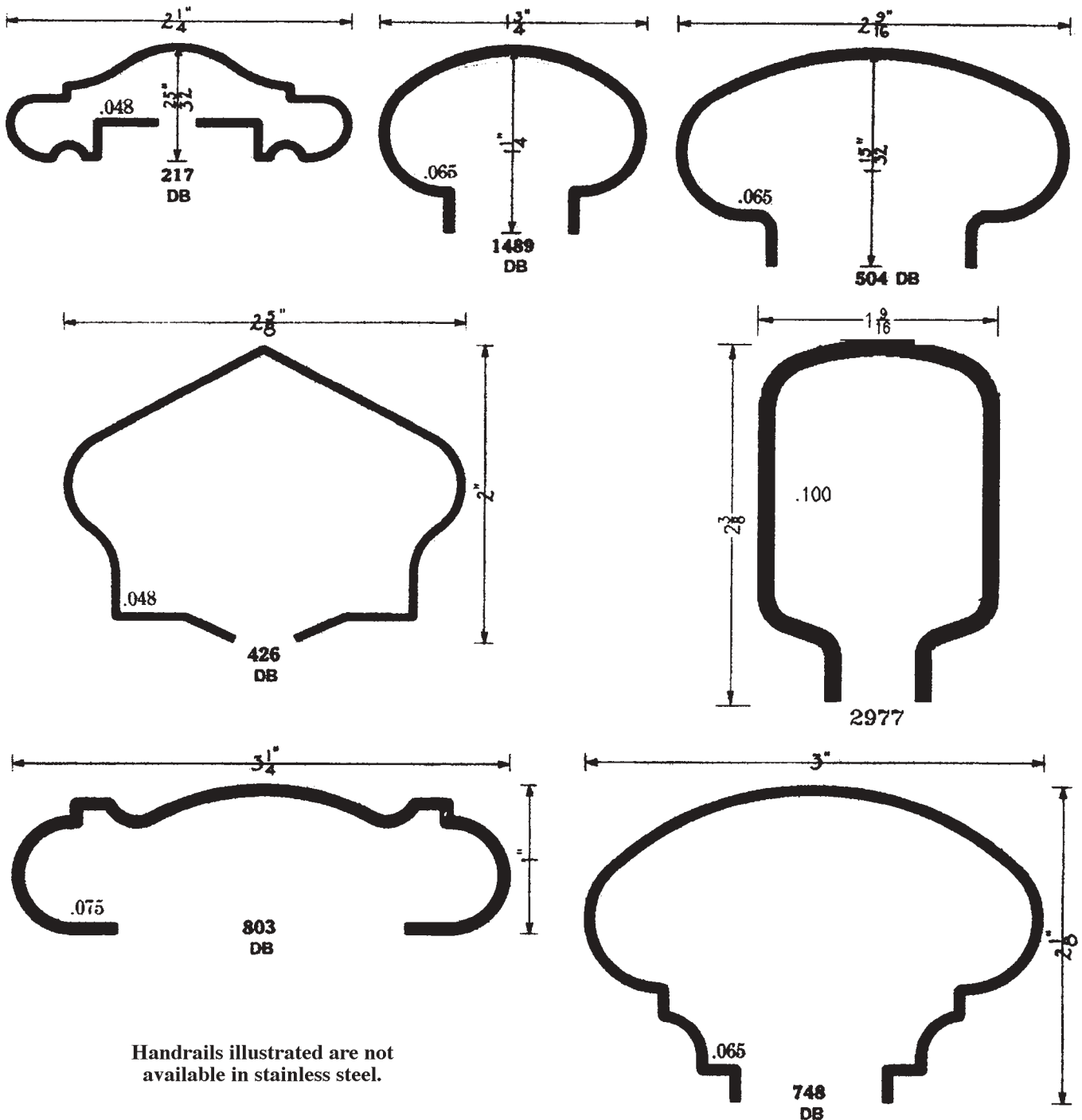
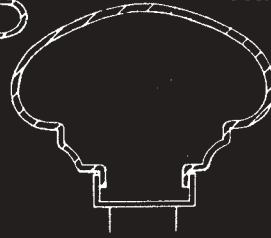

Handrails illustrated are not available in stainless steel.

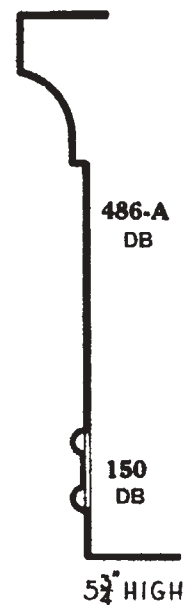
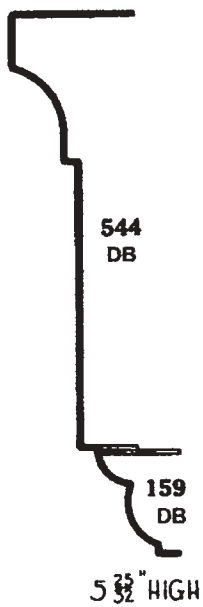
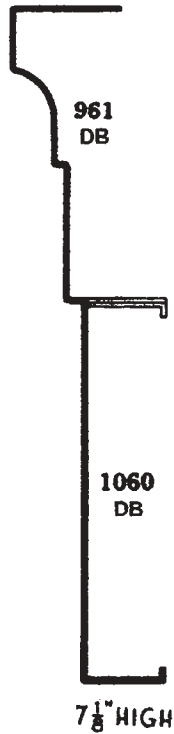
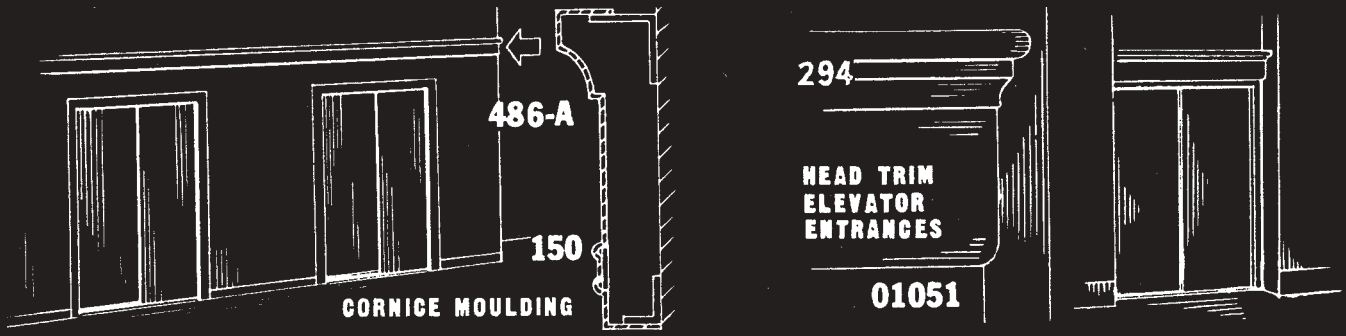

The Cornice Combinations as illustrated above are one-half actual size.